

# HIGH-TECH INNOVATIONS

SIMPLE. SAFE. LIVING.

2023 – 2025





SIMPLE.  
SAFE.  
LIVING.

PFANNER





# OUR PHILOSOPHY. SINCE 1990.

Safety is everyone's concern. **Simple. Safe. Living.**  
This is what PFANNER® has stood for since 1990.

Every head deserves protection. **The original.**  
PROTOS® has been producing the world's safest head  
protection since 2012.

PFANNER® safety solutions protect people who  
approach their limits at work every day. They protect  
people who work outdoors or engage in outdoor  
activities and are thus exposed to the whims of nature.  
Our protective clothing is reduced to the essential: it's  
functional thanks to high-tech materials, comfortable  
to wear and has a contemporary design. Safety and  
comfort are our top priorities.

Discover new products, improved products and  
classics from our diverse range. Let the many  
features you will find throughout the 212 pages of  
our catalogue surprise you.

**Get inspired, from head to toe.**

**Anton Pfanner**

Founder, CEO, Visionary

# YOUR GUIDE



## 4 PFANNER®

Sustainability .....	4
Brands and technologies .....	5
Proven solutions .....	6
Simple. Safe. Living. ....	7



## 8 CHILDREN

Jackets and vests .....	10
T-shirts and sweaters .....	13
Pants and shorts .....	16



## 58 PANTS

Work .....	60
Outdoor .....	68
Rain .....	72
Hunting and tracking .....	74
Forestry .....	78
Tree care .....	84
Chainsaw protection and care instructions .....	88



## 20 JACKETS

Work .....	22
Outdoor .....	28
Hunting and tracking .....	36
Rain .....	44
Tree care .....	48
Forestry .....	53



## 90 FUNCTIONAL CLOTHING

Upper body .....	92
Pants .....	109



# 112 SHOES

Work .....	114
Outdoor .....	120
Forestry .....	125
Insoles .....	139
Socks .....	140



# 142 GLOVES

Work .....	144
Thermal .....	149
Standards and size chart .....	154
Chainsaw protection .....	155



# 156 ACCESSORIES

Our versatile range of accessories stands out with functionality and quality.

# 180 PROTOS®

Safety and comfort .....	184
Industry .....	187
Climber .....	189
Forest .....	191
Arborist .....	193
BT-COM .....	194
Headset .....	196
Accessories .....	198
Colour system .....	203
Unique .....	204

# 206 SERVICE

Finishing .....	208
Size charts .....	210
PFANNER® worldwide .....	211
Imprint .....	212

# SUSTAINABILITY

Sustainability is a priority for us. And especially because we go hand in hand with the forestry industry, our most important principle of action is to deal responsibly with valuable resources.

Based in one of the most beautiful regions of Central Europe, we have the treasures of nature before our eyes every day. In order to preserve them for our children, we see it less as a duty and rather as a natural desire, to minimize the environmental footprint in the manufacturing of our products.

## Made in Europe

To manufacture our products we use high-quality fabrics and accessories from Europe. Regionality is important to us and therefore the majority of employed materials originates in Austria and neighbouring Switzerland. Short transport routes in our European production facilities save time, money and protect the environment.

## Investments

In recent years we have invested a lot. Among other things, in the development of our power supply, since our warehouses now use solar energy instead of oil burners. We are also environmentally conscious during the transport and within the Vorarlberg region we rely on low-emission electric vehicles.

## What you have in your hands

This catalogue and all other print advertising materials are printed on recycled or PEFC certified paper and the process is climate-neutral. Even our packaging, consisting of a mix of recycled and FSC paper, is recyclable.

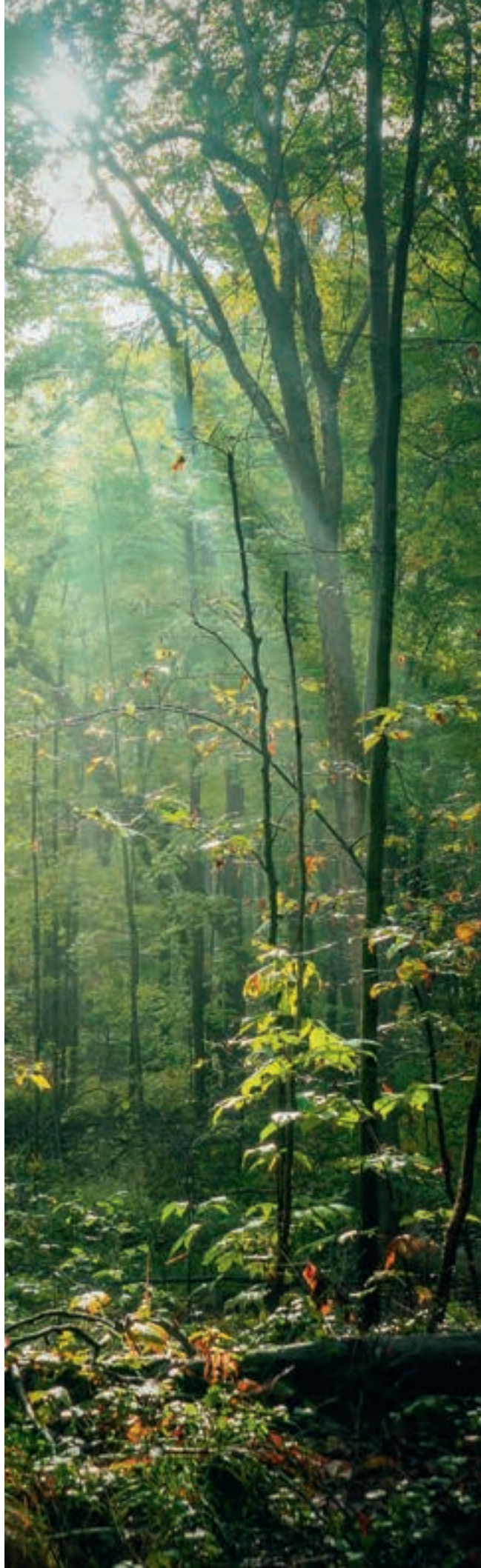



# BRANDS AND TECHNOLOGIES DEVELOPED BY PFANNER®

Customised and innovative solutions require expertise and the knowledge of current technologies and options. Through our proprietary and patented technologies, we have the right solution for every application and stand out due to our individuality.



## Gladiator®

The extremely tear-resistant outer fabric meets the highest demands and is water-repellent, oil and dirt resistant. Besides, it is extremely abrasion-resistant and resistant to thorns.



## StretchFlex®

The proven StretchFlex® technology ensures a perfect fit and enhanced breathability, thus providing maximum comfort.



## KlimaAIR®

Patented rear ventilation system for cooling in summer and thermal insulation in winter. This fabric is used in different thicknesses for shoes as well as jackets and pants.



## Nanoshield®

Water and stain repellent coating. Extremely easy to clean and resistant to natural acids.



## StretchAIR®

Breathable stretch fabrics keep you comfortable during physical exertion. Used with various additional equipment from jackets to functional shirts or pants.



## 3CON®

The 3CON® reflective strips and icons ensure maximum light reflection properties on all fabrics. These provide additional security through increased visibility.



## StretchZone®

Elastic fabric inserts provide more freedom of movement and comfortable wear for jackets and pants. Work wear with added value.



## 100% MembranFREE

Doing without any membranes enables maximum breathability, thus reducing considerably the moisture formation.



## Zipp4Fit®

Patented Zipp4Fit® zip closure system for flexible adaptation to the wearer.

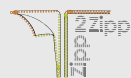

## Zipp2Zipp® pocket system

Enables sensationally convenient access to the sorting compartments.



## AEQUALITAS – Gleichberechtigung®

Absolute equality for right and left-handers. Sophisticated sorting compartments hold all utensils in place.



## Holzer (Lumberjack)

Axe and Picaroon – the forestry equipment for a successful day's work in the forest. Both tools are united in our well thought-out Holzer emblem.

# PROVEN SOLUTIONS ADOPTED BY PFANNER®

High-quality products can only be manufactured with reliable and quality-conscious partners. That is why, besides our own technological developments, we rely on partners who also demand the utmost from their products. Our partnerships have been together for many years, inspiring each other to become better and better.



## Vibram

Abrasion-, water- and winter-resistant rubber soles with exceptional grip for safety shoes and work shoes as well as for mountain and outdoor use. Durable and cushioning with each step.  
[vibram.com](http://vibram.com)



## PU TEK®

High protection and extreme lightness characterize this new, extremely durable material. Breathable, flexible and water-repellent.

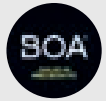

## BOA®

BOA® Fit System: Patented quick-release system for the precise fit of your shoes. Quick and effortless to use.  
[boafit.com](http://boafit.com)



## Sanitized Actifresh

The Sanitized Actifresh finish ensures effective hand protection against bacterial growth and provides all-day protection and freshness. Kind to the skin and dermatologically tested.  
[sanitized.com](http://sanitized.com)



## Sympatex

The Sympatex membrane reliably keeps the body dry and regulates body temperature. Waterproof, breathable, windproof and durable.  
[sympatex.com](http://sympatex.com)



## PrimaLoft®

Keeps you warm and pleasantly dry. PrimaLoft® Gold impresses with its high insulating properties as well as its breathability.  
[primaloft.com](http://primaloft.com)



## Cordura

Its extreme robustness and abrasion resistance characterize the Cordura fabric. Durable, resistant, water- and dirt-repellent.  
[cordura.com](http://cordura.com)



## 3M Scotchlite

Retroreflective properties for significantly increased visibility in all weather conditions and work situations. For your safety.  
[3maustria.at](http://3maustria.at)



## GORE-TEX

Absolutely waterproof and breathable with the "Guaranteed to keep you dry" pledge. Best protection against water and snow meets highest wearing comfort.  
[gore-tex.com](http://gore-tex.com)



## kwf

Risks to forest workers, consumers and the environment are identified and assessed objectively and independently to prevent and avoid accidents and damage.  
[kwf-online.de](http://kwf-online.de)



# WE ARE EXPERTS.

## Simple.

User-friendly, tear-resistant and easy-care functional clothing is a top priority for us. Because that's what defines not only the quality of the materials but also their longevity. The clothing is thus tailored to your particular application. No unnecessary pockets, no unnecessary seams. Everything is exactly where it belongs. The handling is clear and self-explanatory. Our service is personal and uncomplicated. We are pleased to answer any questions or requests you may have.

## Safe.

We are continuously pushing technical expertise and advancements. The use of the latest technical possibilities, combined with innovative ideas, help us to develop new inventions, implemented for your safety. Exceptional quality is not a luxury for us, but essential for your life. Enduring and detailed test phases are an obligation for us, if you entrust your life to our products. Optimal protection and maximum safety are thus always our priority.

## Living.

Life and experience are paramount. Comfort, function and protection are indispensable in daily extreme situations. Quality you can trust – in all regions from north to south. We manufacture under humane and certified conditions in Europe and only use pollutant-free products. Our employees and suppliers also appreciate this.



### Avertic®

In addition to the safety aspects per se, with the chainsaw protection fabric from Avertic® we pay special attention to comfort and durability. [engtex.com](http://engtex.com)



### COOLMAX

Keeps you cool and dries quickly. Excellent moisture management and breathability. With anti-bacterial effect.



### Modal

The lightweight natural wood-based fabric is breathable, soft, cuddly and yet robust and durable. The surface is very smooth and does not itch, so it scores with allergy sufferers. It also offers maximum comfort thanks to its good moisture management.



### Tencel

Cellulose fibres of botanical source set a new standard for sustainability and natural comfort. Thermoregulation for a cool, dry feeling. [tencel.com](http://tencel.com)



### 37.5

Excellent moisture management – regulates the microclimate for maximum comfort and helps the body to maintain a comfort temperature of 37.5 degrees Celsius. [thirtysevenfive.com](http://thirtysevenfive.com)



### Original Alpen Loden

The high-quality merino sheep's wool is processed on state-of-the-art machines to obtain the finest Loden. This quality product meets the highest standards and offers optimal protection against cold and rain. [pischl.at](http://pischl.at)



UP FOR THE  
ADVENTURE.



# ESPECIALLY FOR KIDS.

We have expanded our children's assortment with numerous new items, ranging from the practical StretchAIR® Rain Jacket to the PROTOS® Inuit Teddy Vest and the StretchFlex® Cancool Pants.

**Because we pay special attention to the safety of the little ones.**

<b>Jackets and vests</b>	<b>10</b>
<b>T-shirts and sweaters</b>	<b>13</b>
<b>Pants and shorts</b>	<b>16</b>



## Leopold

Midland Fleece Jacket – Kids .....	15
Holzer Shirt – Kids .....	13
StretchFlex® Canfull Maximus Shorts .....	17

## Stephanie

StretchAIR® Rain Jacket .....	47
Holzer Tank Top .....	101
StretchFlex® Cancool Pants .....	64

## Anna

PROTOS® Inuit Jacket – Kids .....	10
Holzer Shirt – Kids .....	13
Maximus Outdoor Pants .....	18

Person description from left to right.



WORK PROTECTION



OUTDOOR

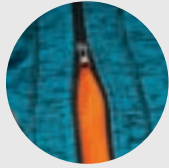

Zipp4Fit® for an optimal fit and ventilation



Softshell hood on P. 174



Family matching look



Zipp4Fit.

&gt;&gt;&gt; 3CON &lt;&lt;&lt;&lt;

100% MEMBRAN FREE



HUMIDITY MANAGEMENT

## PROTOS® Inuit Jacket – Kids

- Robust, dirt-repellent knitted fabric
- Soft flannel on the inside
- Water-repellent shoulder reinforcement
- Scrub resistant elbows
- High collar and extended back
- 3CON® Reflex on the back
- Extra deep inside pockets
- Zipp4Fit® system

PROTOS® Inuit kids jacket made of smooth knitted fabric with dirt-repellent function. The inner is made of soft flannel. The PROTOS® Inuit kid's jacket has water-repellent shoulders, reinforced elbows, a side zipper for a flexible fit and function. The double knit collar and extended kidney protection protect against the cold and the 3CON® Reflex on the back ensures a better visibility.

**Material:**  
100 % PES

**Sizes:**  
S 92/104, M 116/128, L 140/152  
Size flexible through Zipp4Fit® system (variable size)



62



64



60



32



33



65

Item 101350



These items may also interest you:



P. 177



P. 165



P. 30



P. 178



P. 175





WORK PROTECTION



OUTDOOR

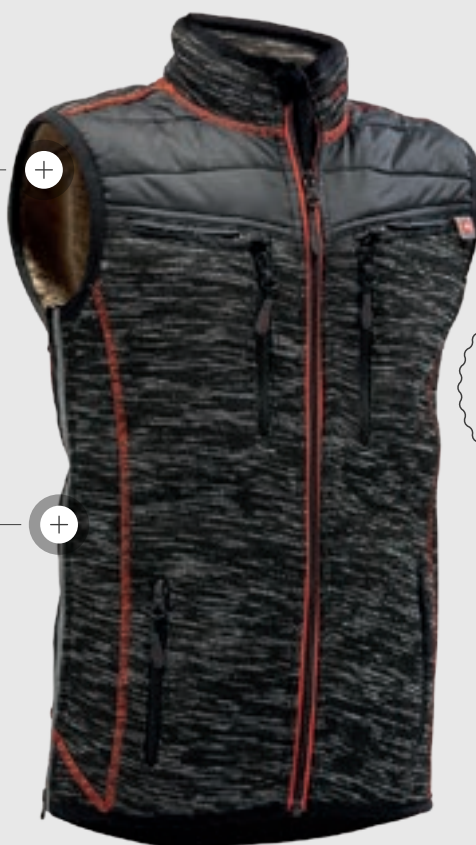
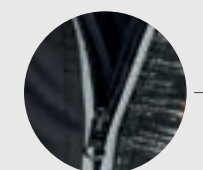
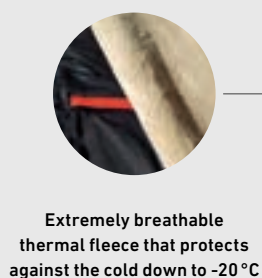

Softshell hood  
on P. 174



Zipp4Fit.

Gleichberechtigt  
LITR3 ehtigung

Zipp2Zipp.

&gt;&gt;&gt;3CON&lt;&lt;&lt;

100% MEMBRAN FREE

PrimaLoft® Gold Insulation

HUMIDITY  
MANAGEMENT

THERMO

## PROTOS® Inuit Teddy Vest – Kids

- Zipp2Zipp® pocket system
- Highly elastic, dirt-repellent knit vest
- Soft and fluffy thermal fleece, lined stand-up collar
- PrimaLoft® Gold padding in front shoulder area
- 3CON® Reflex on the back
- Zipp4Fit® system

PROTOS® Inuit vest made of smooth knitted fabric with dirt-repellent function. The interior of the vest is equipped with a soft, highly breathable and moisture wicking thermal fur. It also has patented Zipp2Zipp® chest pockets, side pockets and extra deep inside pockets on both sides. Side zipper for a flexible fit and function. The soft stand-up collar and the extended back protect the neck and loins from wind and cold.

### Material:

Upper material/lining: 100 % PES  
Front shoulder area: 100 % PrimaLoft® Gold padding

### Sizes:

S 92/104, M 116/128, L 140/152  
Size flexible through Zipp4Fit® system  
(variable size)



66



33



65



67

Item 108463



These items  
may also  
interest you:



P. 175



P. 13



P. 19



P. 17



P. 15



WORK PROTECTION



OUTDOOR

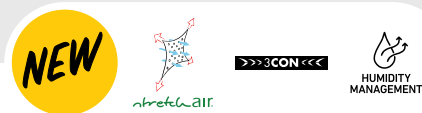

## StretchAIR® Rain Jacket – Kids

- Extremely lightweight, ideal for leisure activities
- Highest breathability
- 20,000 mm water column
- Very comfortable to wear directly on the skin
- 3CON® Reflex on the back
- Extremely small pack size
- No annoying pockets

### Material:

Tear-resistant 4-way-stretch 2.5 layers (2 layers with protective coating), 100 % nylon

### Sizes:

S 92/104, M 116/128, L 140/152



51

Item 106889



## Zipp4Fit® Vest – Kids

- Zipp2Zipp® pocket system
- Lateral size adjustment with Zipp4Fit® (10 possible fitting sizes)
- Elasticated back
- All-around reflective strips
- 3CON® Reflex on the back

### Material:

100 % PES

### Sizes:

One size fits, 104–152



17

Item 104316



These items may also interest you:



P. 18



P. 10



P. 17



P. 158



P. 164





FORESTRY



WORK PROTECTION



OUTDOOR



## Set of 3 Holzer Shirts – Kids

- Shape stability due to shoulder-shoulder neckband
- No side seams
- Holzer logo on left chest
- Three different sizes

### Material:

Forest green: 100 % cotton  
Brilliant black: 80 % cotton, 20 % PES  
Light grey: 85 % cotton, 15 % viscose

### Sizes:

S 92/104, M 116/128, L 140/152



Item 104375

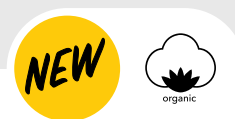

## Set of 3 Holzer Tank Tops – Kids

- Shape stability due to shoulder-shoulder neckband
- No side seams
- Holzer logo on left chest
- Three different sizes

### Material:

Forest green: 100 % cotton  
Brilliant black: 80 % cotton, 20 % PES  
Light grey: 85 % cotton, 15 % viscose

### Sizes:

S 92/104, M 116/128, L 140/152



Item 104360



These items may also interest you:



P. 179



P. 16



P. 174



P. 179



P. 178







WORK PROTECTION



FORESTRY



HUNTING



OUTDOOR



## Holzer All Season 4-piece Set – Kids

- One sweater, one T-shirt and one tank top in a PFANNER® cotton bag
- Holzer logo printed in silver, bronze and gold
- Shape stability due to shoulder-shoulder neckband
- T-shirt and tank top with no side seams
- Unisex, ideal as a gift

### Material:

T-shirt and tank top: 80 % cotton, 20 % PES  
Sweater: 72 % cotton, 20 % PES, 8 % elastane  
Bag: 100 % cotton

### Sizes:

S 92/104, M 116/128, L 140/152



99

Item 104391

## Midland Fleece Jacket – Kids

- Durable knit fleece, soft brushed interior
- StretchFlex® technology
- Water- and dirt-repellent
- Highly elastic 2 x 2 knitted trim on the collar, sleeves and front waistband
- Extended back

### Material:

100 % PES

### Sizes:

S 92/104, M 116/128, L 140/152



38

Item 100038



These items  
may also  
interest you:



P. 164



P. 178



P. 175



P. 163



P. 18



WORK PROTECTION



OUTDOOR



## Olbia Light Pants – Kids

- Highly elastic nylon/spandex 4-way fabric
- Extra light, non-iron and quick drying
- Double sliding waist fastener
- Zipp2Zipp® system on both sides
- Reflective icon on left calf
- Neon yellow zips

**Material:**

88 % nylon, 12 % spandex

**Sizes:**104, 116, 128, 140, 152  
+ 5 cm hem extender

90

Item 102770



## Olbia Light Shorts – Kids

- Highly elastic nylon/spandex 4-way fabric
- Extra light, non-iron and quick drying
- Double sliding waist fastener
- Zipp2Zipp® system on both sides
- Neon yellow zips

**Material:**

88 % nylon, 12 % spandex

**Sizes:**104, 116, 128, 140, 152  
+ 5 cm hem extender

90

Item 102772

These items  
may also  
interest you:

P. 164



P. 169



P. 165



P. 12



P. 13



## StretchFlex® Canfull Maximus

- StretchFlex® technology
- Double waist fastener and preformed knee
- Functional pocket with Velcro (right)
- Integrated zip side pocket (left)
- Single sliding waist fastener
- Reflective Paspol stripes
- Elastic waistband
- 3CON® Reflex

**Material:**  
63 % PES, 34 % cotton, 3 % spandex

**Sizes:**  
104, 116, 128, 140, 152  
+ 5 cm hem extender

Item 107054

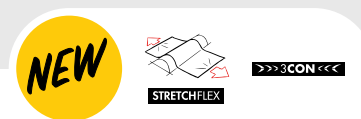

## StretchFlex® Canfull Maximus Shorts

- StretchFlex® technology
- Double waist fastener, reinforced pocket interior
- Functional pocket with Velcro (right)
- Integrated zip side pocket (left)
- Single sliding waist fastener
- Reflective Paspol stripes
- Elastic waistband
- 3CON® Reflex

**Material:**  
63 % PES, 34 % cotton, 3 % spandex

**Sizes:**  
104, 116, 128, 140, 152  
+ 5 cm hem extender

Item 107050



These items  
may also  
interest you:



P. 11



P. 13



P. 178



P. 191



P. 178





WORK PROTECTION

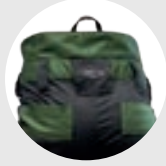

OUTDOOR

Adjustable  
elastic bandFamily matching  
look

&gt;&gt;&gt; 3CON &lt;&lt;&lt;&lt;



## StretchFlex® Cancool Maximus

- StretchFlex® technology
- Double sliding waist fastener
- Zipp2Zipp® pocket system
- Reflective Paspol stripes
- Buttonhole elastic in waistband, suspender loops
- Reinforced pocket interior, preformed knee
- Neon yellow zips
- 3CON® Reflex

**Material:**

58 % cotton, 39 % PES, 3 % spandex

**Sizes:**104, 116, 128, 140, 152  
+ 5 cm hem extender

Item 107074



68



## Maximus Outdoor Pants

- StretchAIR® technology
- Moisture- and dirt-repellent
- Knee reinforcement made of Kevlar
- Back/kidney protection with adjustable suspenders
- Durable design
- Reflective Paspol stripes

**Material:**

83 % EME Lycra, 17 % PES T-400

**Sizes:**92, 104, 116, 128, 140, 152, 164  
+ 5 cm hem extender

Item 101853



40

These items  
may also  
interest you:

P. 177



P. 15



P. 15



P. 169



P. 12

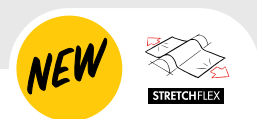

## Gladiator® Suspenders – Kids

- Elastic suspenders
- Adjustable in length by means of Velcro

### Material:

53 % PES, 36 % polyamide, 11 % elastane

### Sizes:

Size 1: up to 128

Size 2: from 128



36

Item 100340



## StretchFlex® Fine Grip

- StretchFlex® technology
- Oil-proof nitrile palm areas
- Breathable and sweat-absorbent
- Slip-free handling
- Repeatedly washable
- Most used glove in all application areas

### Material:

Nylon/nitrile foam

### Sizes:

XXS/5–S/7



16

Item 100050



These items  
may also  
interest you:



P. 175



P. 175



P. 178



P. 159



P. 177





WELL  
EQUIPPED.



# OUR JACKETS.

Robust and dirt-repellent outer fabrics that are windproof and rain-repellent. StretchAIR® technology for a perfect fit and unrestricted freedom of movement. Reflective stripes for safety. Everything a jacket needs.

**Discover our selection of special jackets with detailed solutions.**

<b>Work</b>	<b>22</b>
<b>Outdoor</b>	<b>28</b>
<b>Hunting and tracking</b>	<b>36</b>
<b>Rain</b>	<b>44</b>
<b>Tree care</b>	<b>48</b>
<b>Forestry</b>	<b>53</b>



## Roland

PROTOS® Forest .....	191
PROTOS® BT-COM .....	194
Tencel™-Poly Zipp-Neck Shirt .....	99
KlimaAIR® Hi-Vis Jacket EN 20471 .....	55
Ventilation Chainsaw Protection Pants EN 20471 .....	82
StretchFlex® KeptoTechnic .....	147
Pilatus Class 2 Chainsaw Protection Boots .....	129

## Hannes

PROTOS® Forest .....	191
PROTOS® BT-COM .....	194
Forest Light Jacket .....	53
Gladiator® Keptotec Chainsaw Protection Pants .....	78
StretchFlex® Kepto .....	146
Tyrol Juchten Class 1 Chainsaw Protection Boots .....	135

Person description from left to right.



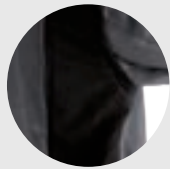

StretchZone®  
technology for  
unparalleled freedom  
of movement

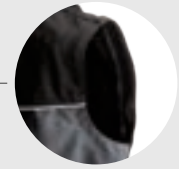

Detachable sleeves



## StretchZone® Canvas Jacket

- StretchZone® technology
- Extremely robust outer fabric
- Detachable sleeves
- Extra-long kidney protection
- Reflective Paspol stripes

Extremely robust canvas fabric for high scrub-resistance and durability. The side pockets are closed with a covered zipper, which prevents the penetration of dirt. Reflective Paspol stripes for enhanced visibility in low light conditions. StretchZone® technology in the back offers an unmatched freedom of movement.

### Material:

Upper: 65 % polyamid Cordura, 35 % cotton  
Stretch fabric: 90 % polyamid, 10 % elastane

### Sizes: (Special products possible)

XS–XL, LS: XXL–3XL

Large sizes + 10 % to 15 % surcharge



13



14



19



55



36



30

Item 102183



These items  
may also  
interest you:



P. 26



P. 191



P. 114



P. 146



P. 63

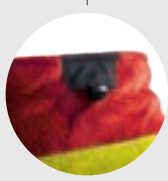

Adjustable collar drawcord

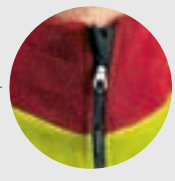

Zipper garage



Optionally available with KlimaAIR® system  
Material: 100 % PES

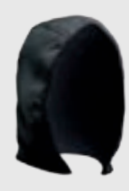

Softshell hood on P. 174

**NEW FEATURES**  
EN 20471  
Gleichberechtigt LITPS-echtigung  
Zipp  
3CON  
100% MEMBRAN FREE  
3M Scotchlite

# Zipp2Zipp® Colour Fleece Jacket

- Zipp2Zipp® pocket system
- Soft comfortable fleece
- Windproof
- Waterproof shoulder reinforcement
- Elastic mesh lining
- Reflective stripes for good visibility throughout
- KlimaAIR® insert with Velcro (optional)
- Inside pocket
- 3CON® Reflex

Zipp2Zipp® Colour Fleece Jacket – recommended for all seasons thanks to the waterproof shoulders and the sewn-in windstopper fabric. The patented Zipp2Zipp® pocket system allows easy storage of mobile phones, notepads and pens. The internal pocket offers additional storage space. The KlimaAIR® system with Velcro attachment can be inserted additionally to optimise the insulating properties of the jacket. Recommended and unique.

**Material:**  
Upper: 100 % PES  
Lining: 100 % PES

**Sizes:**  
XS–XL, LS: XXL–4XL  
Large sizes + 10 % to 15 % surcharge



- Item 102344
- Item 102348 EN 20471
- Item 102417 KlimaAIR® insert

→  
These items may also interest you:



P. 140 P. 61 P. 163 P. 159 P. 45





WORK PROTECTION



FORESTRY



OUTDOOR

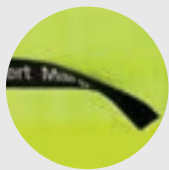

**Name label with Velcro**  
Item 462050 – (chest approx. 11 × 2 cm)



**20-fold lateral size adjustment**  
thanks to Zipp4Fit®

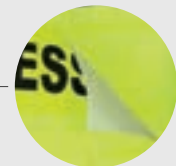

**Function label with Velcro**  
Item 461137-R – (back 39 × 15 cm)  
Item 461137-B – (chest 15 × 15 cm)

**NEW FEATURES**

**Zipp4Fit.** Gleichberd COVA® LITRA3 echtigung

**Zipp2Zipp.**

**3M Scotchlite**

## Zipp4Fit® Slip on Safety Vest

- Zipp2Zipp® pocket system
- Velcro strip for embroidered name emblem
- Front/rear Velcro strip for function labels
- Large neckline, fits over all helmets
- 20-fold lateral size adjustment from S–8XL thanks to Zipp4Fit® zip
- Unisex

Zipp2Zipp® pocket systems and loops for right and left send buttons ensure perfect operability. With the Zipp4Fit® system, the jacket size can be perfectly adjusted 20-fold. The Zipp2Zipp® pocket system provides space for all one-hand radios. Swift assignment of roles thanks to the well thought-out identification vest system. Velcro straps must be attached to the front and back of the garment in order to attach embroidered name badges and function labels. Individual design of function labels in various colours possible. Extra deep neckline – can therefore be slipped over all helmets (especially fire brigade helmets).

**Material:**  
100 % PES

**Sizes:**  
One size, S–8XL



Item 104308



These items may also interest you:



P. 83



P. 191



P. 99



P. 151



P. 138

  
WORK PROTECTION

  
FORESTRY

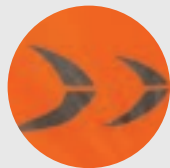
  
HUNTING

3CON® Reflex

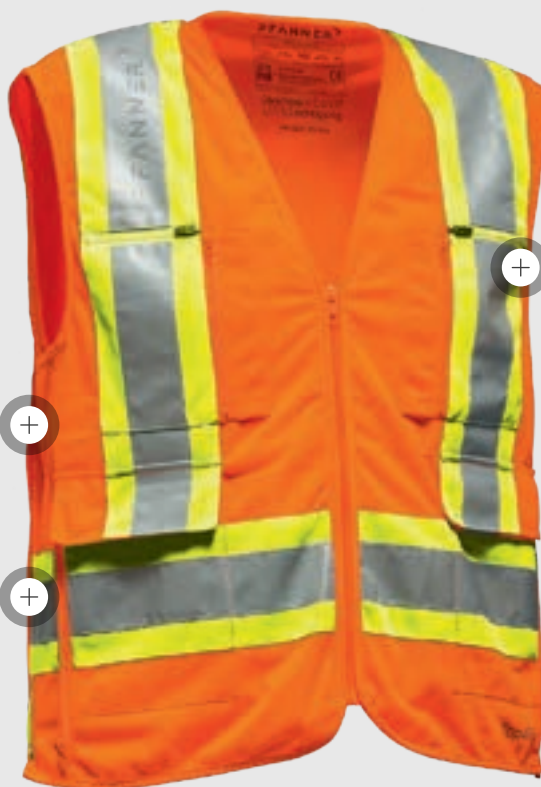
Zipp2Zipp®  
pocket system10-fold lateral size adjustment  
thanks to Zipp4Fit®

Zipp4Fit.

Gleichberechtigt  
LITR3 echtigung

Zipp.

&gt;&gt;&gt;3CON&lt;&lt;&lt;

3M Scotchlite®

## Zipp4Fit® Hi-Vis Vest EN 20471

- Large neckline
- Zipp2Zipp® pocket system
- 10-fold lateral size adjustment from XS–5XL thanks to Zipp4Fit® zip
- Unisex
- Lightweight elastic back
- Certified warning colour EN 20471 class 2
- 3CON® Reflex

Zipp4Fit® system for 10-fold size adjustment. The lightweight elastic back ensures maximum wearing comfort. In addition, the vest has the Zipp2Zipp® pocket system on both sides. The pen holder on both sides opens at the bottom to prevent dirt from accumulating. With the all-around reflective stripes complies with warning protection class 2 according to EN 20471. When all lateral zips are open, visibility increases to the maximum.

The High-Vis Vest is available in one basic colour (25) and six contrasting colours.

**Material:**  
100 % PES

**Sizes:**  
One size, XS–5XL



17

EN 20471

18

EN 20471

56

EN 20471



25

EN 20471

27

EN 20471

28

EN 20471

76

EN 20471

Item 104329



These items  
may also  
interest you:



P. 187



P. 60



P. 60



P. 26



P. 163

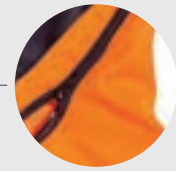

Detachable sleeves



100% MEMBRAN FREE

3M Scotchlite

## StretchZone® Hi-Vis Jacket EN 20471

- Robust outer fabric, napped on the inside
- Water- and dirt-repellent
- Extended back
- Certified warning colour EN 20471
- Scrub-resistant outer fabric
- Detachable sleeves
- Natural feel through cotton inside
- Reflective Paspol stripes

The DIN EN ISO 20471 regulates the rules for increased visibility protective clothing. StretchZone® technology for unlimited freedom of movement. This jacket combines visibility and wear comfort. The robust, water- and dirt-repellent warning fabric guarantees the longevity of the jacket.

### Material:

Upper: 65 % PES, 35 % cotton  
Stretch fabric: 90 % polyamid, 10 % elastane

### Sizes: (Special products possible)

XS–XL, LS: XXL–3XL  
Large sizes + 10 % to 15 % surcharge

25  
EN 2047115  
EN 2047135  
EN 20471

Item 102183 EN 20471



These items  
may also  
interest you:



P. 60



P. 115



P. 165



P. 187



P. 145





WORK PROTECTION



FORESTRY

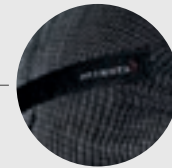

OUTDOOR

Woven-in  
reflective yarns

JACKETS

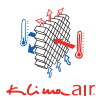
Gleichberechtigt  
LITAS-echtigung

Zipp2Zipp

sympatex®



## KlimaAIR® Reflex Jacket

- Zipp2Zipp® pocket system
- Chest and back with woven-in reflective yarns
- StretchAIR® technology
- KlimaAIR® technology
- Water- and dirt-repellent
- Detachable sleeves, extended back
- High-closing collar
- Sympatex membrane for waterproof shoulders

The proven KlimaAIR® Reflex Jacket is the perfect tool for long working days under variable external conditions. The optimum body climate from early morning until late at night is guaranteed by the KlimaAIR® technology. For all seasons. Thanks to the detachable sleeves, the jacket also allows for an adaptation to the weather conditions. Freedom of movement for all kinds of activities is achieved with the StretchAIR® technology. The reflective fabric processed on chest and shoulders and the 3CON® icons increase the visibility. The Zipp2Zipp® pocket system provides storage and easy access for a note pad or a mobile phone.

### Material:

Stretch fabric: 92 % polyamide, 8 % elastane  
Reflex: 66 % polyamide, 26 % glass fibre, 8 % lycra  
Lining: 100 % PES

### Sizes: (Special products possible)

XS–XL, LS: XXL–4XL  
Large sizes + 10 % to 15 % surcharge



Item 804163-90



90



These items  
may also  
interest you:



P. 61



P. 119



P. 98



P. 191



P. 162





Children's sizes  
P. 10

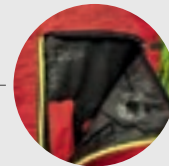

Zipp2Zipp®  
pocket system

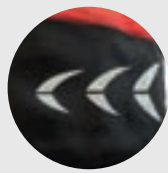

3CON® Reflex



Softshell hood  
on P. 174

JACKETS



Gleichberäugung  
LITRS echtingung

Zipp2Zipp.

>>> 3CON <<<<

100% MEMBRAN FREE



## PROTOS® Inuit Jacket

- Zipp2Zipp® pocket system
- Robust, dirt-repellent knitted fabric
- Soft flannel inside
- Water-repellent shoulder reinforcement
- Scrub resistant elbows
- 3CON® Reflex on the back
- High collar and extended back
- Extra deep inner pockets

The outer fabric of the PROTOS® Inuit Jacket is smooth knitted and protected from dirt by an impregnation. The inner is made of soft flannel. The PROTOS® Inuit Jacket features water-repellent shoulder trims, reinforced elbows, Zipp2Zipp® pocket systems and a napped inside for pleasant wearing comfort. The collar and extended kidney area protection protect against the cold and the 3CON® Reflex on the back ensures better visibility.

**Material:**  
100 % PES

**Sizes:**  
XS–XL, LS: XXL–4XL  
Large sizes + 10% to 15% surcharge



Item 104230



These items may also interest you:



P. 46



P. 92



P. 72



P. 140



P. 126





WORK PROTECTION



TREE CARE

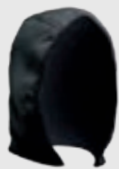

OUTDOOR

Softshell hood  
on P. 174

&gt;&gt;&gt;3CON&lt;&lt;&lt;

100% MEMBRAN FREE

HUMIDITY  
MANAGEMENT

## PROTOS® Inuit Jacket Women

- Robust, dirt-repellent knitted fabric
- Soft flannel inside
- Water-repellent shoulder reinforcement
- Scrub resistant elbows
- 3CON® Reflex on the back
- High collar and extended back
- Extra deep inner pockets
- Side zipper for flexible fit and function

The outer fabric of the PROTOS® Inuit Women's Jacket is smooth knitted for a good protection from dirt and moisture. The inner is made of soft flannel. The fashionably cut PROTOS® Inuit Women's Jacket features water-repellent shoulder trims, reinforced elbows and a napped inside for pleasant wearing comfort. The collar and extended kidney area protection protect against the cold and the 3CON® Reflex on the back ensures better visibility.

**Material:**  
100 % PES

**Sizes:**  
S–XL, LS: XXL  
Large sizes + 10 % surcharge



32



33



65



60

Item 104231



These items  
may also  
interest you:



P. 34



P. 35



P. 39



P. 121



P. 94

-  WORK PROTECTION
-  FORESTRY
-  TREE CARE
-  HUNTING

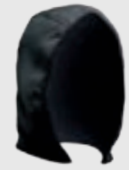

Softshell hood  
on P. 174

JACKETS

**NEW**  Gleichberechtigt LITRS echtingung **Zipp2Zipp.** >>> 3CON <<< 100% MEMBRAN FREE  HUMIDITY MANAGEMENT

## PROTOS® Inuit Vest

- Zipp2Zipp® pocket system
- Robust, dirt-repellent knitted fabric
- Soft flannel inside
- Water-repellent shoulder reinforcement
- 3CON® Reflex on the back

The PROTOS® Inuit Vest is smooth knitted and therefore well protected from dirt and moisture. It features water-repellent shoulder trims, Zipp2Zipp® pocket systems and a napped soft flannel inside for a pleasant wearing comfort. Elastic armholes. The collar and extended kidney area protection protect against the cold and the 3CON® Reflex on the back ensures better visibility.

**Material:**  
100 % PES

**Sizes:**  
XS–XL, LS: XXL–4XL  
Large sizes + 10 % to 15 % surcharge



Item 104224

→  
These items may also interest you:









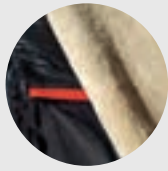

Breathable thermal fleece that protects against the cold down to -20 °C

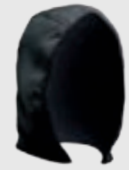

Softshell hood on P. 174

JACKETS

## PROTOS® Inuit Teddy Jacket

- Zipp2Zipp® pocket system
- Highly elastic, dirt-repellent knitted fabric
- Soft and fluffy thermal fleece, lined stand-up collar
- PrimaLoft® Gold padding in front-shoulder area
- Extra deep inner pockets
- 3CON® Reflex on the back
- Scrub resistant elbows

PROTOS® Inuit Teddy Jacket smooth knitted with dirt-repellent function. The inside of the jacket is made of a soft, highly breathable and moisture-wicking thermal fleece. Patented Zipp2Zipp® pocket system on both sides, side pockets and extra-deep inner pockets. The soft, stand-up collar and the extended back protect the neck and loin from wind and cold.

**Material:**  
Upper and lining: 100 % PES  
Front-shoulder area: 100 % PrimaLoft® Gold padding

**Sizes:**  
XS–XL, LS: XXL–4XL  
Large sizes + 10 % to 15 % surcharge



Item 108460

→  
These items may also interest you:





WORK PROTECTION



FORESTRY



TREE CARE



HUNTING



OUTDOOR



Women's tailored fit



PROTOS® Inuit Teddy Vest Women



PROTOS® Inuit Teddy Vest

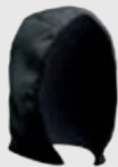

Softshell hood on P. 174



Gleichber...  
LITR...  
echtigung

2Zipp

3CON

100% MEMBRAN FREE

PrimaLoft® Gold Insulation



HUMIDITY MANAGEMENT

THERMO

## PROTOS® Inuit Teddy Vest

- Zipp2Zipp® pocket system
- Robust, dirt-repellent knitted fabric
- Soft and fluffy thermal fleece, lined stand-up collar
- PrimaLoft® Gold padding in front-shoulder area
- Extra deep inner pockets
- 3CON® Reflex on the back
- Side zipper for flexible fit and function (Women's model)

PROTOS® Inuit Teddy Vest smooth knitted with dirt-repellent function. The inside of the vest is made of a soft, highly breathable and moisture-wicking thermal fleece. Patented Zipp2Zipp® pocket system on both sides, side pockets and extra-deep inner pockets. The soft, stand-up collar and the extended back protect the neck and loin from wind and cold.

### Material:

Upper and lining: 100 % PES  
Front-shoulder area: 100 % PrimaLoft® Gold padding

### Sizes:

XS–XL, LS: XXL–4XL  
Large sizes + 10 % to 15 % surcharge  
Women: S–XL, LS: XXL  
Large sizes + 10 % surcharge



66 33 65 67 60



66 33 65 63 67 60

Item 108462 Women  
Item 108461



These items may also interest you:



P. 71



P. 107



P. 111



P. 123



P. 108



Polar Jacket Women

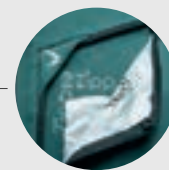

Polar Jacket

Zipp2Zipp®  
pocket systemSoftshell hood  
on P. 174

## Polar Jacket

- Very comfortable to wear
- High-quality fleece
- Freedom of movement through stretch fleece
- Stand-up collar against wind and moisture
- Zipper garage
- Easy-care
- 100 % MembranFREE
- Zipp2Zipp® pocket system (Men's model)

Without membrane for a maximum breathability. In combination with a perfect fit and stretch fleece, the Polar Jacket is the ideal complement to functional clothing at low temperatures or to protect the body from cooling after exercise. The robust and easy-care fleece is also equipped with a high collar and a chin protector. Also available for women with a sporty cut.

**Material:**  
57 % PES, 33 % nylon, 10 % lycra

**Sizes:**  
XS–XL, LS: XXL–3XL  
Large sizes + 10 % to 15 % surcharge  
Women: XS–XL



36



36

81

Item 106657 Women  
Item 102056



These items  
may also  
interest you:



P. 46



P. 174



P. 120



P. 67



P. 159





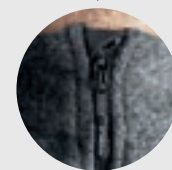
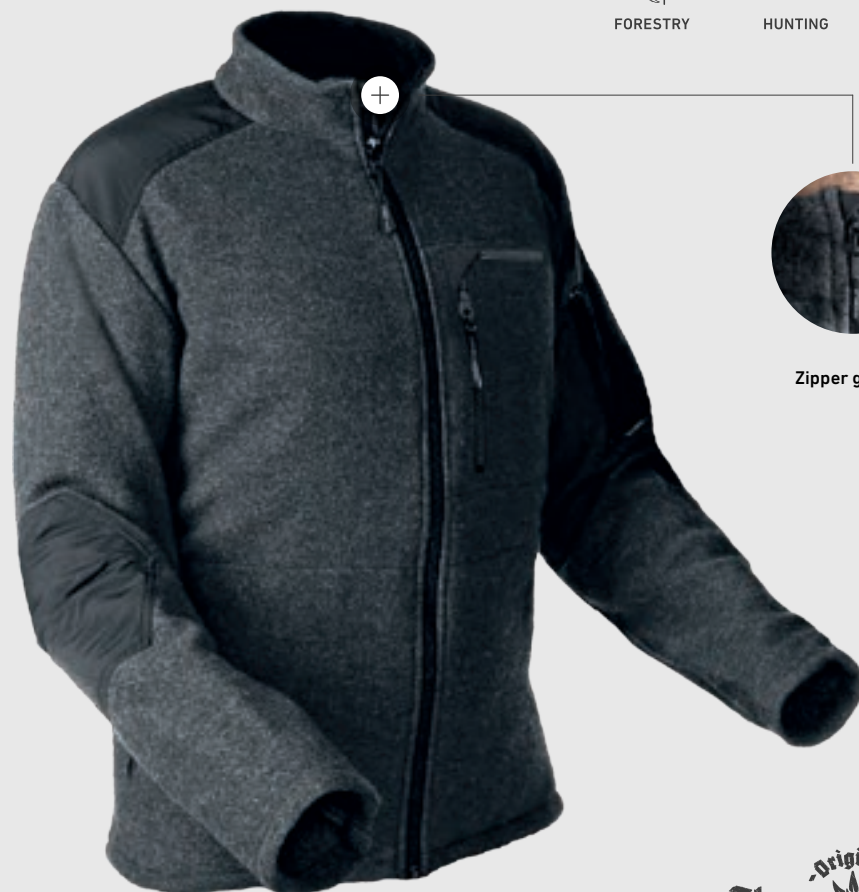

Zipper garage

Original  
Alpen  Loden

Zipp2Zipp.

100% MEMBRAN FREE



## Wooltec Jacket

- High-quality merino wool
- Naturally odourless, water- and dirt-repellent and flame retardant
- Quiet fabric
- 100 % MembranFREE
- Zipp2Zipp® pocket system

Its quiet characteristics make the Wooltec Jacket perfect for hunting, when silent movements are essential. But the Wooltec Jacket is also a perfect companion for other outdoor activities. The upstanding collar prevents the penetration of dirt and protects against wind gusts. The Wooltec Jacket is made from 100 % merino wool. Merino wool does not absorb odours and does not scratch the skin. The zipper is covered with a chin protector to prevent scratching the chin.

### Material:

Upper: 100 % merino wool  
Trim: 100 % polyamide

### Sizes:

S–XL, LS: XXL–3XL  
Large sizes + 10 % to 15 % surcharge



38

90

Item 101206



These items  
may also  
interest you:



P. 74



P. 92



P. 140



P. 111



P. 95





FORESTRY



HUNTING



OUTDOOR

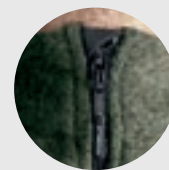

Zipper garage

Original  
Alpen  Coden

Zipp2Zipp.

100% MEMBRAN FREE

  
HUMIDITY  
MANAGEMENT

  
MERINO

## Wooltec Gilet

- High-quality merino wool
- Naturally odourless, water- and dirt-repellent and flame retardant
- Quiet fabric
- 100 % MembranFREE
- Zipp2Zipp® pocket system

The sleeveless complement to the Wooltec Hooded Jacket, made of 100 % merino wool. The Wooltec Gilet has excellent insulation properties and water-repellent shoulder reinforcements. Merino wool is very comfortable to wear, does not absorb odours and does not scratch the skin.

### Material:

Upper: 100 % merino wool  
Trim: 100 % polyamide

### Sizes:

S–XL, LS: XXL–3XL  
Large sizes + 10 % to 15 % surcharge



38



90

Item 101207



These items  
may also  
interest you:



P. 111



P. 108



P. 121



P. 159



P. 111





Original  
Alpen Coden



Women's  
tailored fit



Wooltec Hooded Jacket Women



Wooltec Hooded Jacket

2Zipp.  
Zipp

100% MEMBRAN FREE

HUMIDITY  
MANAGEMENT

MERINO

## Wooltec Hooded Jacket

- High-quality merino wool
- Naturally odourless, water- and dirt-repellent and flame retardant
- Quiet fabric
- Special athletic fit for women (Wooltec Hooded Jacket Women)
- 100 % MembranFREE
- Zipper garage
- Zipp2Zipp® pocket system (Men's model)

The Wooltec Hooded Jacket is a pleasant outdoor and leisure jacket for women and men who enjoy the outdoors. The cut ensures the right fit. Made without a membrane, this jacket guarantees breathability. The merino wool prevents the creation of unpleasant odours and is dirt- and water-repellent. With the waterproof shoulder reinforcements and the hood, you are also equipped for short-term weather changes.

### Material:

Upper: 100 % merino wool  
Trim: 100 % polyamide

### Sizes:

S–XL, LS: XXL–3XL  
Large sizes + 10 % to 15 % surcharge  
Women: XS–XL



38



90



36

Item 106698 Women  
Item 101206-36



These items  
may also  
interest you:



P. 95



P. 153



P. 121



P. 68



P. 175







HUNTING



**NEW FEATURES**

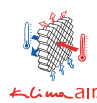

GleichberEIGNUNG  
LITAs echtigung

Zipp.  
Zipp.

sympatex®

3M Scotchlite®

## Gladiator® Tracking Jacket

- Zipp2Zipp® pocket system
- Quick access to weapons with the side zipper
- Extremely thorn- and tear-resistant outer fabric
- Sympatex membrane for waterproof chest and shoulder areas
- 50 cm long air vents in the underarm area
- Spacious game pocket
- High-closing collar
- Adjustable ventilation in the back area

Tracking often picks up speed quickly and a jacket has to endure everything. The Gladiator® Tracking Jacket has an extremely tear-resistant outer fabric with which thorns are not noticeable. The StretchAIR® and Klima AIR® technologies ensure breathability and maximum freedom of movement, which increases the wear comfort.

### Material:

Upper 1: 83 % EME lycra, 17 % PES T-400  
Stretch fabric: 92 % polyamide, 8 % elastane  
Upper 2: 100 % polyamide Cordura  
Lining: 100 % PES (Volume: 95 % air and 5 % PES)

### Sizes: (Special products possible)

XS–XL, LS: XXL–4XL  
Large sizes + 10 % to 15 % surcharge

The additional ventilation at the back prevents collapsing due to overheating. The high-closing collar prevents the penetration of pine needles and other debris into the jacket. The Zipp2Zipp® pocket system with the eye for signal band removal and reflective stripes ensure the visibility in the undergrowth.



Item 804335



60



39



These items may also interest you:



P. 77



P. 193



P. 97



P. 146



P. 132





WORK PROTECTION



FORESTRY



HUNTING



OUTDOOR

Children's sizes  
P. 15

Midland Fleece Jacket



Highland Fleece Jacket

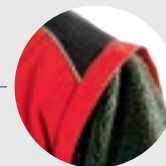

Detachable sleeves



100% MEMBRAN FREE



## Midland / Highland Fleece Jacket

- Durable knit fleece
- Extended back
- StretchFlex® technology
- Water- and dirt-repellent
- Zipper garage
- Highly elastic 2 x 2 knitted trim on the sleeves and the front waistband
- 100 % MembranFREE (Midland)
- Detachable sleeves and reflective Paspol stripes (Highland)
- Cordura shoulder reinforcements as well as waterproof and windproof design (Highland)

Item 100036 Midland  
Item 106790 Highland

Fleece jackets made of high quality knit fleece. The plushy fleece surface provides a natural repellence effect without a membrane. The extended back effectively protects the kidney area from cooling. The chin protectors round off the wear comfort of the jacket. The Highland Fleece Jacket is equipped with waterproof Cordura on the chest and back area. Detachable sleeves allow turning the jacket into a vest at all times.

### Material:

Midland: 100 % PES  
Highland: Upper 1: 100 % PES  
Upper 2: 97 % PES, 3 % spandex  
Lining: 100 % PES

### Sizes: (Special products possible)

XS–XL, LS: XXL–4XL  
Large sizes + 10 % to 15 % surcharge



38



302



38



These items  
may also  
interest you:



P. 95



P. 75



P. 111



P. 141



P. 159

  
WORK PROTECTION

  
FORESTRY

  
HUNTING

  
OUTDOOR

Grizzly Jacket

Grizzly Sweater

Softshell hood  
on P. 174

## Grizzly Jacket / Sweater

- Durable knit fleece
- Water- and dirt-repellent shoulder and elbow reinforcements
- Practical sleeve pocket
- Napped flannel inside
- Easy-care
- 3CON® Reflex

The Grizzly Jacket will keep you warm. Thanks to the knit fleece, it has perfect insulation properties and optimally maintains the temperature when it is freezing outside. The knit fleece is extremely comfortable to wear on the skin and does not scratch, due to the napped flannel inside. The water-repellent shoulder reinforcements and the sleeve pocket complete the profile of this jacket. Also available as a sweater with a short zip.

**Material:**  
60 % PES, 20 % polyacrylics, 20 % viscose

**Sizes:**  
S–XL, LS: XXL–4XL  
Large sizes + 10 % to 15 % surcharge



90

90

Item 101318 Jacket  
Item 101110 Sweater



These items  
may also  
interest you:



P. 95



P. 108



P. 65



P. 161



P. 117







WORK PROTECTION FORESTRY HUNTING OUTDOOR



Optionally available with KlimaAIR® system

Material: 100 % PES

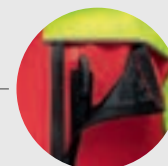

Zipp2Zipp® pocket system

JACKETS

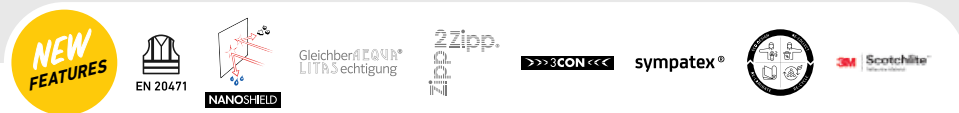

## Nanoshield® Rain Jacket

- Zipp2Zipp® pocket system
- Jacket closure zipper with rain flap
- Inside pocket with zipper
- Extended back
- Mesh lining
- 20,000 mm water column
- 100 % recyclable
- Including a hood
- 3CON® Reflex
- KlimaAIR® insert with Velcro (optional)
- Reflective Paspol stripes

20,000 mm water column and waterproof zippers make the Nanoshield® Rain Jacket 100 % waterproof. The inside pocket, the innovative Zipp2Zipp® pocket system and side entry pockets provide plenty of storage space for mobile phones and other utensils. The extended back reliably protects the kidney area from cooling down and the 3CON® Reflex icons ensure maximum visibility. The jacket is 100 % recyclable including the membrane and thus environment-friendly.

Material: 100 % PES

Sizes: XS–XL, LS: XXL–4XL  
Large sizes + 10 % to 15 % surcharge

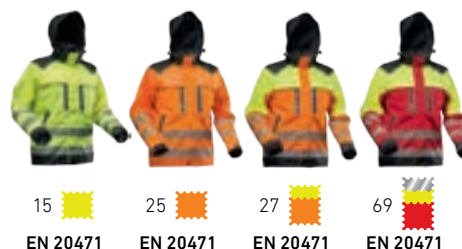

Item 106694  
Item 102417 KlimaAir® insert



These items may also interest you:



P. 73



P. 187



P. 114



P. 177



P. 108



WORK PROTECTION



OUTDOOR

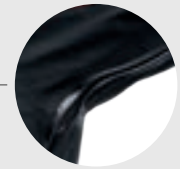

Zipper in the armpits for additional ventilation



sympatex®

3M Scotchlite



HUMIDITY MANAGEMENT

## Ventura Rain Jacket

- 20,000 mm water column
- Front zipper with wind flap
- Elastic outer fabric
- Velcro fastener at sleeves
- High-closing collar with chin protection
- Optional hood

### Note:

Not suitable for fir needles. They pierce the membrane.

The Ventura Rain Jacket has a Sympatex membrane for reliable moisture protection with highest wear comfort. This membrane ensures water-tightness at maximum breathability. This way, the jacket is particularly suitable for physically demanding activities. The zipper in the armpits can be opened for an additional ventilation. The Velcro fastener on the sleeves can be adjusted individually and prevents the penetration of dirt and water. The new reflective stripes and 3CON® Reflex icons now provide the Ventura Rain Jacket with even better visibility and therefore additional safety.

### Material:

Stretch fabric: 90 % PES, 10 % elastane  
Lining: 100 % PES

### Sizes:

S–XL, LS: XXL–3XL  
Large sizes + 10 % to 15 % surcharge



60



36



Item 102089

Item 106997 Hood



These items may also interest you:



P. 73



P. 72



P. 35



P. 120



P. 177



WORK PROTECTION



OUTDOOR

Children's sizes  
P. 12Gleichberächtigungs-  
LITRAGEchtigung

Zipp2Zipp.

&gt;&gt;&gt;3CON&lt;&lt;&lt;



&gt;&gt;&gt;3CON&lt;&lt;&lt;



## Zipp2Zipp® Stretch Rain Jacket

- 20,000 mm water column
- Zipp2Zipp® pocket system
- Highest breathability
- 3CON® Reflex for better visibility

### Material:

Tear-resistant 4-way-stretch 2.5 layers  
(2 layers with protective coating)  
100 % nylon

### Sizes:

XS–XL, LS: XXL–3XL

Large sizes + 10 % to 15 % surcharge



51

Item 106885

## StretchAIR® Rain Jacket

- Extremely lightweight (size M weighs 220 g) and highest breathability
- Ideal for leisure activities, also for wearing in alpine regions
- Extremely small pack size
- Very comfortable to wear directly on the skin
- 20,000 mm water column
- 3CON® Reflex

### Material:

Tear-resistant 4-way-stretch 2.5 layers  
(2 layers with protective coating)  
100 % nylon

### Sizes:

XS–XL, LS: XXL–4XL

Large sizes + 10 % to 15 % surcharge



36

51

Item 106886



These items  
may also  
interest you:



P. 67



P. 73



P. 105



P. 116



P. 139







FORESTRY



TREE CARE

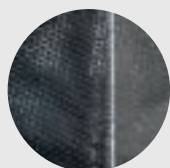

Silicone print prevents the jacket from slipping when wearing a climbing harness

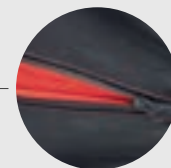

Zipper in the armpits for additional ventilation

JACKETS

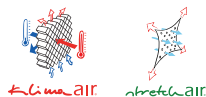

100% MEMBRAN FREE



## Arborist Jacket

- Silicone print prevents slipping of the climbing harness
- StretchAIR® and KlimaAIR® technology
- Unrestricted freedom of movement
- 100 % MembranFREE
- Water- and dirt-repellent outer fabric
- 50 cm long underarm ventilation
- Elastic cuffs
- Reflective Paspol stripes

The Arborist Jacket is the jacket for professionals. The silicone print on the lower back of the jacket ensures that it stays under the climbing harness. The clever pocket arrangement makes it possible to stow all things quickly and in an accessible manner, even when wearing the climbing equipment. Through the KlimaAIR® and StretchAIR® technologies, the freedom of movement in the branches and the wear comfort are guaranteed. The high-closing collar prevents the penetration of the branches and foreign objects into the neck area.

### Material:

Stretch fabric: 92 % polyamide, 8 % elastane  
Lining: 100 % PES

### Sizes:

XS–XL, LS: XXL–3XL  
Large sizes + 10 % to 15 % surcharge



16



14

Item 102220



These items may also interest you:



P. 85



P. 123



P. 108



P. 193



P. 155



FORESTRY



TREE CARE

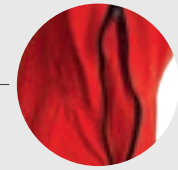

Vents in the underarm area for additional ventilation



EN 20471



class 1 20m/s



KlimaAIR



StretchAIR



3M ScotchLite



Kwif

## StretchAIR® Chainsaw Protection Jacket

- Chainsaw protection class 1 throughout the front area including collar and arms
- StretchAIR® technology
- KlimaAIR® technology
- Extremely robust and tear-resistant outer fabric
- Waterproof shoulder reinforcement
- Lining from high-quality functional fibre
- 50 cm long air vents in the underarm area

The jacket for all extreme work where chainsaw protection of class 1 is mandatory in the entire front area, including arms and collar. Thanks to StretchAIR® and KlimaAIR® technologies in the back area, the wear comfort is guaranteed. The air vents under the arms provide additional ventilation. The extremely robust and tear-resistant outer fabric ensures the longevity of the StretchAIR® Chainsaw Protection Jacket.

### Material:

Upper warning colours: 83 % EME lycra, 17 % PES  
Stretch fabric: 92 % polyamide, 8 % elastane  
Lining: 100 % Cocona PES  
Chainsaw protection: Dyneema

### Sizes:

XS–XL, LS: XXL–3XL  
Large sizes + 10 % to 15 % surcharge



25  
EN 20471



60

Item 102191



These items may also interest you:



P. 82



P. 193



P. 194



P. 99



P. 125





FORESTRY



TREE CARE



HUNTING

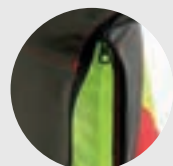
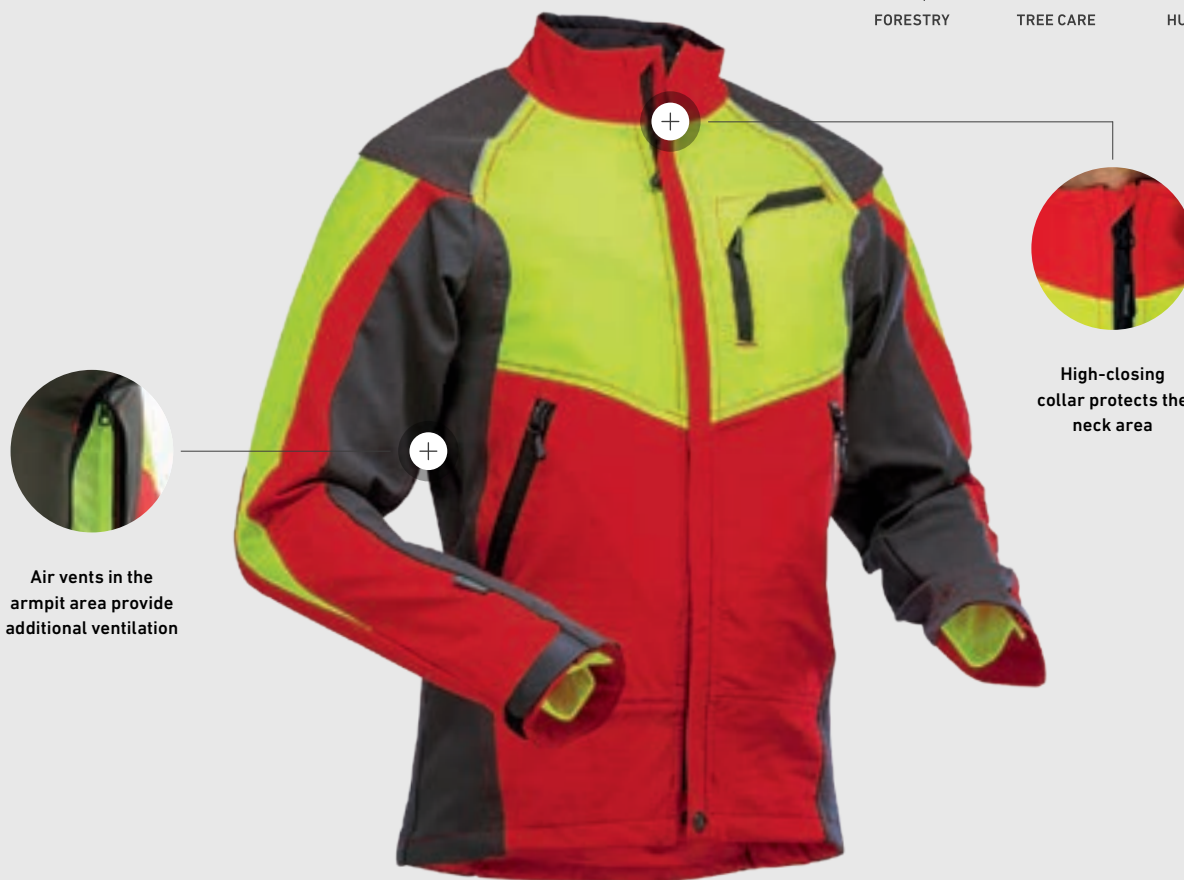

Air vents in the armpit area provide additional ventilation

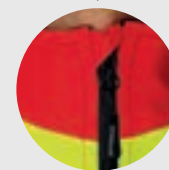

High-closing collar protects the neck area



100% MEMBRAN FREI



## Ventilation Jacket

- StretchAIR® technology
- KlimaAIR® technology
- Unrestricted freedom of movement
- Water- and dirt-repellent outer fabric
- 50 cm long underarm ventilation
- Elastic functional cuffs
- High-closing collar
- Zipp2Zipp® pocket system
- Reflective Paspol stripes

The extremely lightweight Ventilation Jacket is designed for warm working days. The breathable StretchAIR® technology guarantees maximum freedom of movement and breathability. KlimaAIR® technology ensures the ventilation of the jacket, which can be maximized using the 50 cm long air vents in the armpit area. The Zipp2Zipp® pocket system provides an easily accessible storage space. The high-positioned front pouch pockets are also accessible when wearing a tool belt and climbing harness.

### Material:

Upper: 83 % EME lycra, 17 % PES  
 Upper warning colours: 92 % PES, 8 % elastane  
 Stretch fabric: 92 % polyamide, 8 % elastane  
 Lining: 100 % PES

### Sizes: (Special products possible)

2XS–XL, LS: XXL–3XL  
 Large sizes + 10 % to 15 % surcharge



20

37

60



19

38

362

Item 105544



These items may also interest you:



P. 81



P. 193



P. 194



P. 93



P. 127



WORK PROTECTION



FORESTRY



TREE CARE

**NEW**GleichberEQUUR  
LITAs echtigung

Zipp2Zipp

&gt;&gt;&gt;3CON&lt;&lt;&lt;&lt;



## KlimaAIR® Vest

- StretchAIR® technology
- KlimaAIR® technology
- Elastic, water- and dirt-repellent outer fabric
- KlimaAIR® spacer fabric throughout
- Zipp2Zipp® pocket system
- 3CON® Reflex
- Reflective stripe on chest and back
- High-closing collar
- Zipper garage
- Long cut

Our StretchAIR® technology makes the KlimaAIR® Vest particularly suitable for the warmer seasons. The 4-way-stretch outer fabric ensures maximum freedom of movement and is extremely resistant to branches and thorns. The patented Zipp2Zipp® pocket system on both sides provides optimal storage space for notepads, pens and mobile phones. Visibility increases significantly with the continuous reflective stripes and the proven 3CON® logos.

**Material:**

Red outer fabric: 90 % polyamide, 10 % elastane  
Neon yellow outer fabric: 92 % PES, 8 % elastane  
Lining: 100 % PES

**Sizes:**

XS–XL , LS: XXL–3XL  
Large sizes + 10 % to 15 % surcharge



14



36



60

Item 100041



These items  
may also  
interest you:



P. 104



P. 103



P. 81



P. 140



P. 119



WORK PROTECTION



FORESTRY



TREE CARE



Forest Light Jacket



Forest Light Vest

Gleichberäufige  
LITR3-echtigung

Zipp2Zipp.

&gt;&gt;&gt; 3CON &lt;&lt;&lt;&lt;

100% MEMBRAN FREE

## Forest Light Jacket / Vest

- StretchAIR® technology
- Unrestricted freedom of movement
- Elastic, water- and dirt-repellent outer fabric
- Underarm ventilation
- High-closing collar
- Zipp2Zipp® pocket system
- Elastic reflective stripes
- 3CON® Reflex
- Waterproof shoulder reinforcement

Item 102244 Jacket

Item 102245 Vest

The Forest Light Jacket is extra light but still robust. Our StretchAIR® technology and the armpits ventilation make it particularly suitable for the warmer seasons. The 4-way-stretch outer fabric ensures maximum freedom of movement and is extremely resistant to branches and thorns. The patented Zipp2Zipp® pocket system on both sides provides optimal storage space for notepads, pens and mobile phones. Two inner pockets create additional storage room. The inner sleeve cuffs ensure that the sleeve hem fits optimally to each wrist. Visibility increases significantly with the continuous reflective stripes and the proven 3CON® logos.

**Material:**

Red outer fabric: 90 % polyamide, 10 % elastane  
Neon yellow outer fabric: 92 % PES, 8 % elastane

**Sizes:**

XS–XL, LS: XXL–3XL

Large sizes + 10 % to 15 % surcharge



60



60



These items may also interest you:



P. 98



P. 97



P. 75



P. 158



P. 177







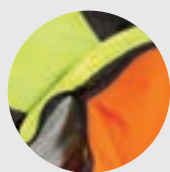

Detachable sleeves



KlimaAIR® technology

Gleichberäugung  
LITR3 echtigung

sympatex®



## KlimaAIR® Hi-Vis Jacket EN 20471

- StretchAIR® technology
- KlimaAIR® technology
- Detachable sleeves
- Zipp2Zipp® pocket system
- Certified warning colour EN 20471 class 3
- Extended back
- High-closing collar
- Sympatex membrane for waterproof chest and shoulder areas

In cases of restricted visibility, an early detection is required for safety purposes. Our KlimaAIR® Hi-Vis Jacket complies with EN 20471 class 3 for increased visibility and offers optimal wear comfort. Our StretchAIR® and KlimaAIR® technologies ensure unrestricted mobility and optimum ventilation.

### Material:

Upper: 83 % EME lycra, 17 % PEST-400

Lining: 100 % PES

### Sizes: (Special products possible)

XS–XL, LS: XXL–4XL

Large sizes + 10 % to 15 % surcharge



27

EN 20471

Item 804163-27



These items may also interest you:



P. 99



P. 60



P. 191



P. 25



P. 131



WORK PROTECTION



FORESTRY



TREE CARE

EN 20471  
class 3

100% MEMBRAN FREE

3M Scotchlite



## Ventilation Hi-Vis Jacket EN 20471

- Certified warning colour EN 20471 class 3
- StretchAIR® technology
- KlimaAIR® technology
- Unrestricted freedom of movement
- Water- and dirt-repellent outer fabric
- 50 cm long underarm ventilation
- Elastic cuffs prevent the penetration of dirt
- High-closing collar
- Zipp2Zipp® pocket system

In fog, darkness and other conditions with limited visibility, early detection is mandatory for safety. Our Ventilation Hi-Vis Jacket complies with EN 20471 class 3. Our StretchAIR® and KlimaAIR® technologies ensure unrestricted freedom of movement and optimum wear comfort. This jacket with adjustable underarm ventilation is designed and optimised for warm working days. The Zipp2Zipp® pocket system allows easy access to materials and the high-positioned front pouch pocket provides sufficient space, even when wearing a tool belt.

### Material:

83 % EME lycra, 17 % PES

### Sizes: (Special products possible)

XXS–XL, LS: XXL–3XL

Large sizes + 10 % to 15 % surcharge

25   
EN 20471

Item 105544-25



These items  
may also  
interest you:



P. 177



P. 191



P. 99



P. 147



P. 126



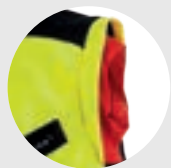

Detachable sleeves

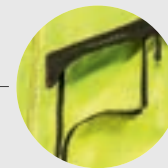
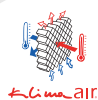
Zipp2Zipp®  
pocket system

Gleichberäckerung  
LITAS-echtigung



## KlimaAIR® Forest Jacket

- StretchAIR® technology
- KlimaAIR® technology
- High-closing collar
- Extremely robust
- Waterproof shoulders
- Water- and dirt-repellent
- Zipp2Zipp® pocket system
- Spare sleeves available separately (Item 107031)

Proven for decades – the KlimaAIR® Forest Jacket is our all-time favourite. KlimaAIR® and Stretch-AIR® technologies ensure maximum wearing comfort – for the entire year. The removable sleeves and the additional ventilation at the back guarantee work without collapsing even on hot days. The water- and dirt-repellent outer fabric is extremely tear-resistant and ensures the longevity of the jacket.

### Material:

Upper: 83 % EME lycra, 17 % PES T-400  
Stretch fabric: 92 % polyamide, 8 % Elastane  
Lining: 100 % PES

### Sizes: (Special products possible)

XS–XL, LS: XXL–4XL  
Large sizes + 10 % to 15 % surcharge

The patented Zipp2Zipp® pocket system on both sides provides storage and optimal access for a note pad or mobile phone. The high-closing collar prevents the penetration of the branches and dirt.



Item 804163

Item 107031 Sleeves



20



60



These items may also interest you:



P. 83



P. 191



P. 107



P. 145



P. 129



**PERFECT FIT AND  
COMFORTABLE.**



# OUR PANTS.

Depending on the application area, different functions are required. For forestry work, tear resistance and chainsaw protection. Increased visibility, dirt, oil and water and repellent properties for extreme conditions in daily work. Robustness and breathability for outdoor activities. Our selected product range offers the right pants for each of your missions, with a perfect fit and maximum freedom of movement.

**Because you are the one wearing the pants.**

<b>Work</b>	<b>60</b>
<b>Outdoor</b>	<b>68</b>
<b>Rain</b>	<b>72</b>
<b>Hunting and tracking</b>	<b>74</b>
<b>Forestry</b>	<b>78</b>
<b>Tree care</b>	<b>84</b>
<b>Chainsaw protection and care instructions</b>	<b>88</b>



<b>Florian</b>	
PROTOS® Industry .....	187
PROTOS® Hearing Protection .....	200
Zipp2Zipp® Colour Fleece Jacket .....	23
StretchFlex® Kepro .....	146
StretchFlex® Canfull Zipp2Zipp® Pants .....	65
Nanoshield® 840 S3 .....	114





WORK PROTECTION



100% MEMBRAN FREE

3M Scotchlite

## StretchZone® Hi-Vis Pants / Hi-Vis Shorts EN 20471

- Certified warning colour EN 20471
- New: certified warning colour class 2
- StretchZone® technology
- Gladiator® Cordura knee reinforcement
- Velcro kneepad insertion slot
- Six functional pockets including special triple yardstick pocket
- Highest elasticity in the buttocks area

Item 501030 Pants  
Item 501033 Shorts  
Item 501130-25 Thermal pants

The StretchZone® Hi-Vis Pants EN 20471 are our all-round pants for the most versatile activities that require an increased visibility without missing out wearing comfort. Six functional pockets suitable for any application. Gladiator® knee reinforcement with Velcro opening. StretchZone® technology assures the perfect fit of the pants. The elastic gusset in the crotch area and the multi-point locks in the seat seam prevent tearing and overstretching of the seams.

### Material:

Upper: 70 % PES, 30 % cotton  
Stretch fabric: 90 % polyamide, 10 % elastane

### Sizes: (Special products possible)

42–56, LS: 58–62  
Large sizes + 10 % to 15 % surcharge  
+ 5 cm hem extender



\* only up to size 60

25  
EN 2047115  
EN 2047135  
EN 2047125  
EN 2047115  
EN 2047135  
EN 20471

These items  
may also  
interest you:



P. 55



P. 187



P. 99



P. 26



P. 145



WORK PROTECTION

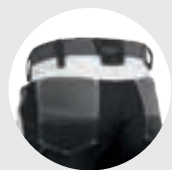

Stretch fabric  
in the buttocks area

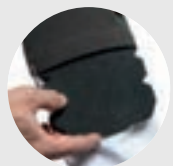

Knee pads are  
easy to insert via the  
Velcro opening



## StretchZone® Canvas Pants / Shorts

- StretchZone® technology
- Maximum freedom of movement
- Gladiator® knee reinforcement
- Knee pad pocket with Velcro opening
- Triple yardstick pocket
- Tear-resistant gusset
- Napped flannel inside
- Reflective Paspol stripes
- New: Full-length elastic waistband

Item 501030 Pants

Item 501033 Shorts

Item 501130-14 Thermal pants

StretchZone® Canvas Pants – the perfect pants for daily work. The StretchZone® technology ensures optimum hold and ventilation for all activities. The well-planned layout of the pockets for everyday use, including a special yardstick and tools triple pocket, offers space for all utensils. StretchZone® Canvas Shorts – the perfect addition for warm days, without missing out functions and pockets.

### Material:

Canvas: 65 % PES, 35 % cotton  
Stretch fabric: 90 % polyamide, 10 % elastane

### Sizes: (Special products possible)

40–56, LS: 58–62  
Large sizes + 10 % to 15 % surcharge  
+ 5 cm hem extender



\* only up to size 60



13 14 19 55 36 30



13 14 55 36 30



These items  
may also  
interest you:



P. 187



P. 194



P. 22



P. 168



P. 168



WORK PROTECTION



Knee pads (P. 168) are easy to insert via the Velcro opening

NEW  
FEATURES



100% MEMBRAN FREE

## StretchZone® Canvas Overall

- StretchZone® technology
- Gladiator® knee reinforcement
- Unrestricted freedom of movement
- High kidney protection
- Tear-resistant gusset
- Reflective Paspol stripes
- Knee pad pocket with Velcro opening

Our StretchZone® Canvas Overall offers optimal freedom of movement through the StretchAIR® technology. Additional chest pockets for extra storage space. Gladiator® knee reinforcement with Velcro opening. These pants feature a raised kidney protection area with an elastic and slipping-free support structure.

### Material:

Canvas: 65 % PES, 35 % cotton  
Stretch fabric: 90 % polyamide, 10 % elastane

### Sizes: (Special products possible)

42–56, LS: 58–62  
Large sizes + 10 % to 15 % surcharge  
+ 5 cm hem extender



14

15

30

Item 100929

Item 100929-15 Neon yellow



These items  
may also  
interest you:



P. 187



P. 140



P. 22



P. 95



P. 116



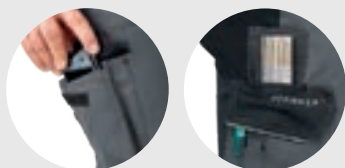

The integrated yardstick and phone pockets provide storage space for all standard tools



100% MEMBRAN FREE



## StretchZone® Spirit Pants

- StretchZone® technology
- Athletic fit
- Side pocket with integrated yardstick pocket
- Very light
- Reflective Paspol stripes

StretchZone® Spirit Pants – for work in changing positions that does not require knee pads. Through their stretch properties, the full freedom of motion is maintained. The lightweight pants with an athletic, slim fit will inspire you even after a long day's work. The side pocket with integrated yardstick and phone pocket provides storage space for all standard tools.

### Material:

Canvas: 65 % PES, 35 % cotton  
Stretch fabric: 90 % polyamide, 10 % elastane

### Sizes: (Special products possible)

40–56, LS: 58–62  
Large sizes + 10 % to 15 % surcharge  
+ 5 cm hem extender



14



36

Item 101947



These items may also interest you:



P. 27



P. 93



P. 117



P. 140



P. 187



WORK PROTECTION

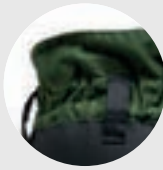

Suspender loops and extra high kidney protection

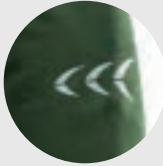

3CON® Reflex on the back



**NEW**



Gleichberechtigt  
LITRA® echtigung

Zipp2Zipp.

>>>3CON<<<

100% MEMBRAN FREE

## StretchFlex® Cancool Pants / Shorts

- StretchFlex® technology
- Extra-light
- Preformed knee
- Zipp2Zipp® pocket system
- Yardstick insert
- Extra-high kidney protection
- Loops for PFANNER® suspenders
- YKK sliding press studs
- Reflective Paspol stripes
- 3CON® Reflex
- Very high wearing comfort

StretchFlex® Cancool Pants – ideal for gardening and landscaping. Very lightweight, scrub-resistant cotton blend fabric. For all weather conditions and landscaping requirements. The raised kidney protection with loops for PFANNER® suspenders optimally protects the sensitive body areas. The integrated Zipp2Zipp® pocket system on both sides offers plenty of space for small tools. StretchFlex® Cancool Shorts – the perfect addition for warm days, without missing out functions and pockets.

### Material:

58 % cotton, 39 % PES, 3 % spandex

### Sizes:

42–56, LS: 58–62

Large sizes + 10 % to 15 % surcharge  
+ 5 cm hem extender



68



68

Item 107075 Pants

Item 107076 Shorts



These items may also interest you:



P. 114



P. 141



P. 42



P. 25



P. 166



WORK PROTECTION



PANTS

Gleichberechtigt  
LITAS echtigung

Zipp2Zipp.

&gt;&gt;&gt;3CON&lt;&lt;&lt;

100% MEMBRAN FREE

## StretchFlex® Canfull Zipp2Zipp® Pants / Shorts

- StretchFlex® technology
- Double waist fastener
- Zipp2Zipp® pocket system
- Yardstick slot and functional pocket with Velcro fastener (right)
- Reinforced pocket interior and YKK sliding press studs
- Reflective Paspol stripes
- 3CON® Reflex
- Sporty wearing comfort

StretchFlex® Canfull Zipp2Zipp® Pants – robust work pants made of extremely scrub-resistant fabric. The Zipp2Zipp® pocket system on both sides and the functional pocket on the right leg provide plenty of storage space. The entire pants are made of a 2-way-stretch fabric, which ensures a comfortable wearing feeling. For warm days, we recommend the StretchFlex® Canfull Zipp2Zipp® Shorts.

**Material:**  
63 % PES, 34 % cotton, 3 % spandex

**Sizes:**  
42–56, LS: 58–62  
Large sizes + 10 % to 15 % surcharge  
+ 5 cm hem extender



14



58



14



58

Item 107065 Pants  
Item 107066 Shorts



These items  
may also  
interest you:



P. 22



P. 98



P. 164



P. 169



P. 43







WORK PROTECTION



HUNTING



OUTDOOR



## Olbia Light Pants / Shorts

- Highly elastic nylon/spandex 4-way fabric
- Extra-light, only 330 grams in size M
- Zipp2Zipp® pocket system with integrated Pocket Office solution on both sides
- Non-iron and quick-drying
- Double slide lock buttons

### Material:

88 % nylon, 12 % spandex

### Sizes:

XS-3XL

Large sizes + 10 % to 15 % surcharge  
+ 5 cm hem extender

90

90

Item 102760 Pants

Item 102762 Shorts

Item 102860 Thermal pants

## Olbia Extreme CC Pants

- The all-rounder
- Cordura for maximum tear resistance
- Zipp2Zipp® pocket system with integrated Pocket Office solution on both sides
- Climate-regulating organic cotton
- Elastic fabric with 57 % cotton content
- Very light, only 400 grams in size M
- Double slide lock buttons

### Material:

57 % organic cotton, 40 % cordura, 3 % spandex

### Sizes:

XS-4XL

Large sizes + 10 % to 15 % surcharge  
+ 5 cm hem extender

90

Item 101268

These items  
may also  
interest you:

P. 119



P. 94



P. 38



P. 169



P. 109



OUTDOOR

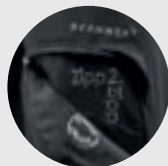

The Zipp2Zipp® pocket system provides plenty of storage space



New: innovative belt loops for belts up to 4 cm wide

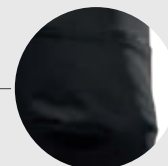

Preformed knees increase the freedom of movement and provide high wear comfort

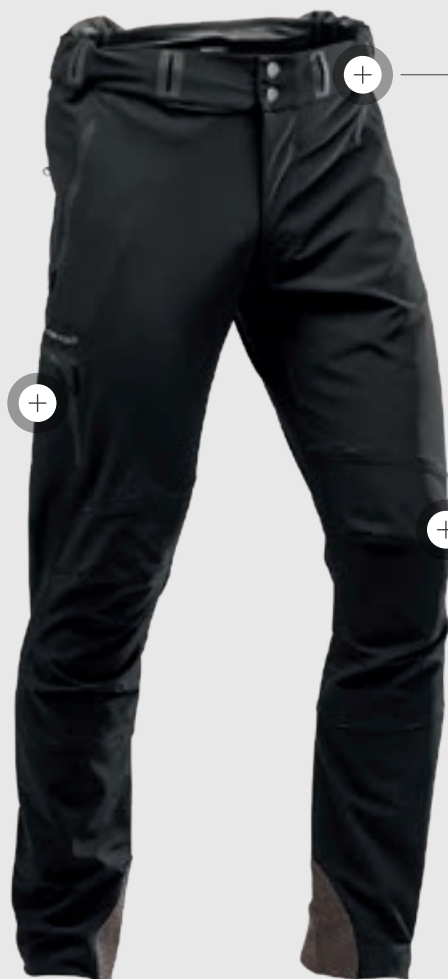

Zipp2Zipp

100% MEMBRAN FREE



## Concept Outdoor Pants

- StretchAIR® technology
- Zipp2Zipp® pocket system
- Preformed Kevlar knees
- Extra high 5 cm waistband with innovative belt loops
- Kevlar reinforcement
- Water- and dirt-repellent
- Very light, only 430 grams in size M
- Zipp2Zipp® pocket system
- Extremely robust
- New: Belt width up to 4 cm possible

The Concept Outdoor Pants are very lightweight and extremely durable. In the usual PFANNER® manner, it offers maximum breathability and freedom of movement thanks to the StretchAIR® technology. That is why the Concept is particularly suitable for extensive hiking and climbing tours. The Kevlar reinforcement at the ankle insides protect the pants from wear. Innovative design of the belt loops, which ensures an even seat of the pants while wearing a belt.

### Material:

89 % polyamide, 11 % elastane

### Sizes: (Special products possible)

XXS–XL, LS: XXL–3XL

Large sizes + 10 % to 15 % surcharge



36



92

Item 101760



These items may also interest you:



P. 121



P. 169



P. 94



P. 39



P. 174



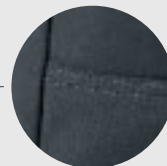

Robust, waterproof knee  
reinforcement



## Thermo Outdoor Pants

- Merino inside
- Robust polyamide exterior
- StretchAIR® technology
- Water- and dirt-repellent
- Integrated gaiters
- Robust and waterproof knee reinforcement
- Reflective Paspol stripes

Our Thermo Outdoor Pants offer maximum comfort, not just on cold days. The warm merino wool provides natural and functional insulation. Maximum moisture- and odour-management while maintaining breathability and freedom of movement are further characteristics of the thermal pants. Integrated gaiters protect particularly against the penetration of snow and dirt.

### Material:

74 % polyamide, 20 % merino wool, 6 % elastane

### Sizes: (Special products possible)

XS–XL, LS: XXL

Large sizes + 10 % surcharge



36 

Item 100072



These items  
may also  
interest you:



P. 163



P. 167



P. 29



P. 111



P. 141





WORK PROTECTION



HUNTING



OUTDOOR

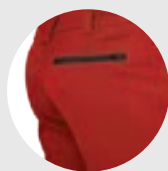

Integrated, extra-large  
zipped back pocket

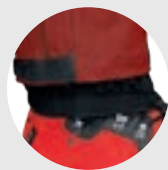

Zip-able gaiters  
protect from ticks, dirt  
and snow



Extendable  
with zip-off  
suspenders



Extendable  
with Gladiator®  
suspenders



100% MEMBRAN FREE

## Globe Outdoor Pants

- Kevlar knee and leg inside reinforcement
- StretchAIR® technology
- Zip-able gaiters
- Water- and dirt-repellent
- Fast drying
- Reflective Paspol stripes

Perfect for demanding outdoor activities. The extremely elastic and robust outer fabric provides maximum freedom of movement being very lightweight and breathable as well. The Kevlar reinforcement on the knees and leg inside increases the durability and provides extra protection while climbing. Zip-able gaiters protect specially from ticks, dirt and snow.

**Material:**  
92 % polyamide, 8 % elastane

**Sizes: (Special products possible)**  
XS–XL, LS: XXL–3XL  
Large sizes + 10 % to 15 % surcharge



40



38



90

Item 102096



These items  
may also  
interest you:



P. 124



P. 95



P. 37



P. 169



P. 167





WORK PROTECTION



OUTDOOR

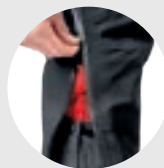

Full-length leg  
zippers

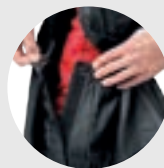

Integrated gaiters protect  
from water and dirt



sympatex®

## Ventura Rain Pants

- Sympatex membrane
- Water column 20,000 mm
- Full-length two-way side zipper
- Waist size adjustable with Velcro
- Cordura knee reinforcement
- Zip-able gaiters
- Waterproof side slit pockets

### Note:

Not suitable for thorns.  
They pierce the membrane.

The flexible and elastic upper material guarantees absolutely reliable weather protection. The zippers along the entire leg length enable easy dressing and undressing over pants and shoes. The Ventura Rain Pants are equipped with a Sympatex membrane for optimum protection from rain and wind. The stretch fabric makes them ideal for all outdoor activities.

### Material:

90 % polyamide, 10 % elastane

### Sizes: (Special products possible)

XS–XL, LS: XXL

Large sizes + 10 % surcharge



36

Item 102184



These items  
may also  
interest you:



P. 45



P. 46



P. 111



P. 166



P. 162



WORK PROTECTION



HUNTING



OUTDOOR

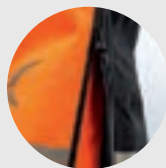

Extended side zip closure

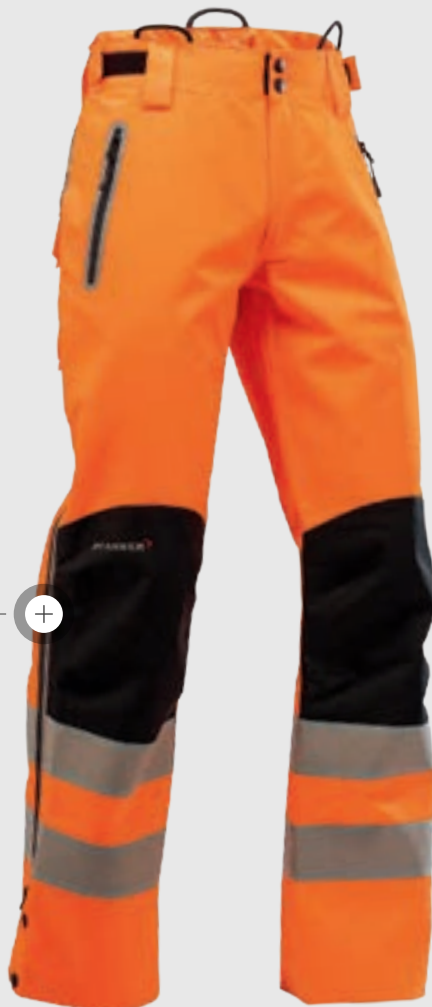
EN 20471  
class 2

&gt;&gt;&gt;3CON&lt;&lt;&lt;

sympatex®



3M Scotch-lite®

## Nanoshield® Rain Pants EVO

- Sympatex membrane
- Waterproof zipper
- Waterproof side slit pockets
- Cordura knee reinforcement
- Belt and suspender loops
- Water column 20,000 mm
- Yardstick and mobile phone pocket
- Waist fastener
- 3CON® Reflex
- Certified warning colour EN 20471 class 2
- 100 % recyclable
- New: with extended side zip closure

The Nanoshield® Rain Pants EVO are completely waterproof with a water column of 20,000 mm. With their yardstick and mobile phone pockets and the waist fastener, they are full-fledged work pants. Side zips up to above the knees allow easy access while wearing shoes. By the Nanoshield® Rain Pants EVO we do not leave out the belt loops and the straps for suspenders. The pants are also available in warning colours. 3CON® Reflex for additional visibility.

### Note:

Not suitable for thorns.  
They pierce the membrane.

### Material:

100 % PES

### Sizes:

XS–XL, LS: XXL–4XL  
Large sizes + 10 % to 15 % surcharge



90



38



36

15  
EN 2047125  
EN 20471

Item 106695



These items may also interest you:



P. 177



P. 114



P. 45



P. 145



P. 167



HUNTING



OUTDOOR

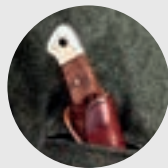

Knife pocket



MERINO

**Please note delivery time!**  
Natural product with high demand for raw materials.

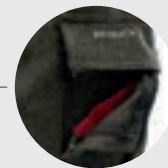

Zipp2Zipp® pocket system

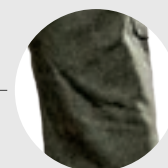

Improved fit thanks to new cut

Original  
**Alpen Loden**

**NEW**  
FEATURES

Gleichberäuber  
LITRAs echtigung

2Zipp.  
ZIPP

100% MEMBRAN FREE

HUMIDITY  
MANAGEMENT

MERINO

## Loden Pants

- Noiseless and dirt-repellent merino Loden fabric
- Cocona lining
- Better fit through new, ergonomic cut
- High kidney protection
- Knife pocket
- Zipp2Zipp® pocket system
- Zip-able gaiters

The original PFANNER® Loden Pants made of traditional Tyrolean Loden fabric, with extra-high waistband and a practical Zipp2Zipp® pocket system, are absolutely noiseless. The Cocona lining with the natural fibres prevents skin irritation and provides maximum wear comfort, since it wicks moisture away from the body. The high content of merino wool ensures natural odour-inhibition and is self-cleaning in the event of soiling. Zip-able gaiters provide effective protection from ticks, dirt and snow.

### Material:

Upper: 67 % merino wool, 25 % polyamide,  
5 % alpaca wool, 3 % elastane  
Lining: 100 % Cocona PES

### Sizes: (Special products possible)

XS–XL, LS: XXL  
Large sizes + 10 % surcharge



short  
regular  
long



38

Item 101593



These items may also interest you:



P. 124



P. 169



P. 167



P. 153



P. 37





  
WORK PROTECTION

  
FORESTRY

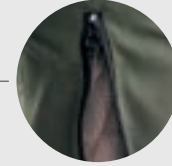
  
TREE CARE

  
HUNTING

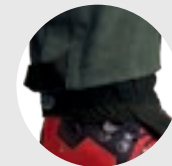

Ventilation zips for maximum temperature compensation



Zip-able gaiters protect from ticks and dirt

**NEW FEATURES**

  
EN 20471  
class 3

  
GLADIATOR

  
KlimaAIR

  
StretchAIR

sympatex®

3M | ScotchLite®

  
HUMIDITY  
MANAGEMENT

## Gladiator® Outdoor Pants

- Ventilation zippers
- Gladiator® outer fabric
- KlimaAIR® technology
- StretchAIR® technology
- Kevlar knee reinforcement
- Velcro kneepad pocket
- Zip-able gaiters
- Sympatex liner
- Available in bright orange with reflective stripes EN 20471 class 3
- Reflective Paspol stripes

Our tear-resistant Gladiator® outer fabric makes the Gladiator® Outdoor Pants ideal for extreme demands. The water- and dirt-repellent outer material is extremely easy to clean. The StretchAIR® technology on the back ensures freedom of movement and the perfect fit of the pants. The Cocona lining wicks away moisture. The ventilation zips on the KlimaAIR® fabrics provide maximum ventilation and temperature compensation on the back. In addition, these pants feature the special yardstick and tools triple pocket. The Sympatex liner guarantees a waterproof front.

### Material:

Front: 100 % polyamide Cordura  
Stretch fabric: 92 % polyamide, 8 % elastane  
Lining: 100 % Cocona PES

### Sizes: (Special products possible)

XS–XL, LS: XXL–4XL  
Large sizes + 10 % to 15 % surcharge



36 



38 



40 



51 



90 



25 

EN 20471



Item 804488



These items may also interest you:



P. 73



P. 166



P. 51



P. 146



P. 98









HUNTING

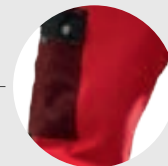

New cut and lighter materials for a better fit

PANTS

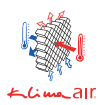

sympatex®



## Gladiator® Tracking Pants

- KlimaAIR® technology
- StretchAIR® technology
- Gladiator® outer fabric
- Waterproof Sympatex membrane
- High-cut back
- Significant weight reduction due to its new design
- Integrated gaiters to protect from ticks, snow and dirt
- Dyna-Tusker-Immunity stab protection with Cocona functional lining

New cut redesigned to increase the freedom of movement with much lower weight (1.25 kg in size M). The continuous ventilation fabric at the front prevents the accumulation of heat. The Gladiator® outer fabric is extremely tear-resistant and water-repellent. The new Dyna-Tusker-Immunity stab protection ensures maximum protection from boars, animal bites and snakes. Integrated gaiters provide additional protection from dirt and ticks. The Tracking Pants combine know-how and maximum safety for hunting and tracking.

### Material:

Front: 100 % polyamide Gladiator®  
Stretch fabric: 92 % polyamide, 8 % elastane  
Lining: 100 % Cocona PES

### Sizes: (Special products possible)

XS–XL, LS: XXL–3XL  
Large sizes + 10 % to 15 % surcharge



40



38



Item 804332



These items may also interest you:



P. 193



P. 111



P. 97



P. 147



P. 41





Also available in light version

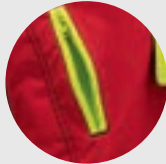

Ventilation slits on the backside

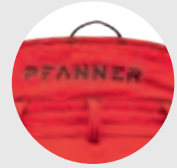

Suspender loops and extra-high kidney protection

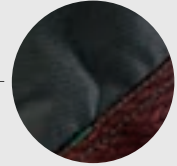

Proven Keprotect fabric on the front of the thigh and lower leg and in the heel area



**NEW**

EN 381-5 | TYPE A  
class 1, 20m/s

GLADIATOR

stretch.all

HUMIDITY MANAGEMENT

## Gladiator® Keprotect Chainsaw Protection Pants

- Chainsaw protection class 1
- Keprotect fabric on the front of the thigh and lower leg and in the heel area
- Gladiator® knee reinforcement
- Tear-resistant 4-way-stretch fabric
- Ventilation slits on both sides
- Raised back section (kidney protection)
- Reflective icon on left calf
- New: Summer version with breathable fabric in the crotch and seat area

The Gladiator® Keprotect is a practical chainsaw protection pant that appeals not only to instructors, apprentices, forestry workers or machine operators, but also to private buyers. It features sporty Gladiator® knee reinforcements, a back pocket, a side pocket, a yardstick pocket and two front pockets. Ventilation slits make it comfortable to wear on hot days.

**Material:**

Stretch fabric: 92 % polyamide, 8 % elastane  
Knee reinforcement: 100 % polyamide  
Lining: 100 % Cocona PES

**Sizes:**

XS–XL, LS: XXL–3XL  
Large sizes + 10 % to 15 % surcharge



40



40

Also available in light version

Item 102193  
Item 102193 Light

→  
These items may also interest you:



P. 146



P. 111



P. 53



P. 127



P. 166

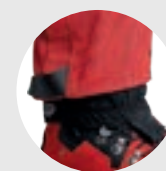
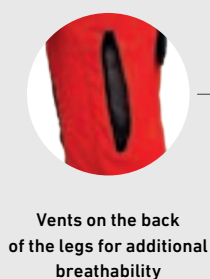

## Gladiator® II Chainsaw Protection Pants

- Chainsaw protection class 2
- Vents on the backside
- Extremely tear- and thorn-resistant
- StretchAIR® technology
- Gladiator® fabric
- Preformed knee reinforcement
- Removable gaiters
- KlimaAIR® thermoregulator

The chainsaw protection class 2 provides increased protection up to a chain speed of 24 m/s. StretchAIR® technology assures the perfect fit of the pants. The preformed knee reinforcements and the extra protection on the inside of the legs increase the durability. The KlimaAIR® thermoregulator at the waist provides maximum comfort even for chainsaw protection class 2.

### Material:

Front: 100 % polyamide Cordura  
Stretch fabric: 92 % polyamide, 8 % elastane  
Lining: 100 % Cocona PES  
Chainsaw protection: Dyneema

### Sizes: (Special products possible)

XS–XL, LS: XXL–3XL  
Large sizes + 10 % to 15 % surcharge



Item 102155



These items may also interest you:



P. 191



P. 132



P. 50

Scan the QR code to learn more about the proper care of the chainsaw protection products.











FORESTRY



TREE CARE

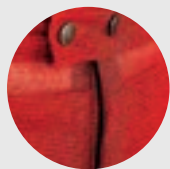

Mesh fabric prevents accumulation of heat

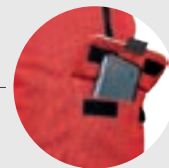
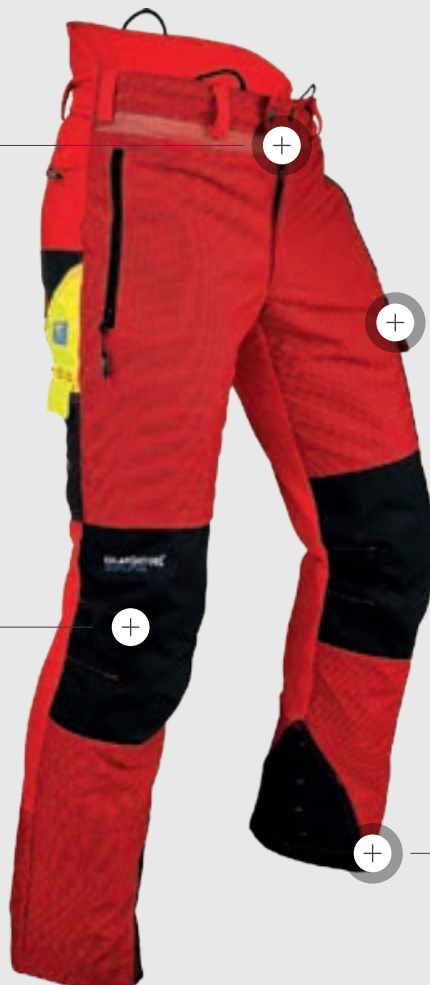

Functional side pocket for important tools

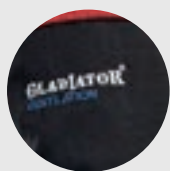

Preformed knee reinforcements

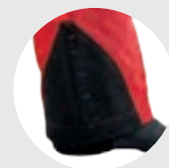

Gladiator® reinforcement

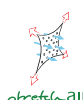
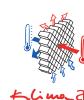
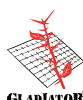

## Ventilation Chainsaw Protection Pants Type A / Type C

- The light one (Type A)
- KlimaAIR® technology
- StretchAIR® technology
- Removable gaiters (Type A)
- Tear-resistant Gladiator® outer fabric
- Dyneema chainsaw protection class 1
- Preformed knee reinforcement
- Lining made of functional fibre
- Reflective Paspol stripes
- All-round chainsaw protection only Type C Pants

Due to the Dyneema chainsaw protection the pants remain lightweight and the StretchAIR® technology provides the optimal hold. The preformed knee reinforcements and the extra protection on the inside of the legs increase the durability. The KlimaAIR® thermoregulator in the waistband prevents heat accumulation. The proven Type C Chainsaw Protection Pants are designed for people who run the risk of sawing into the back of their legs when working. Type C chainsaw protection encloses the entire leg.

### Material:

Front: 100 % polyamide Gladiator®  
Stretch fabric: 92 % polyamide, 8 % elastane  
Lining: 100 % Cocona PES  
Chainsaw protection: Dyneema

### Sizes: (Special products possible)

XXS–XL, LS: XXL–3XL  
Large sizes + 10 % to 15 % surcharge



36



37



40



51



90

Item 101761 Type A  
Item 102078 Type C



These items may also interest you:



P. 169



P. 177



P. 98



P. 51



P. 166



FORESTRY



TREE CARE

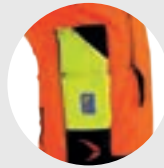

Triple pocket for  
yardstick and tools

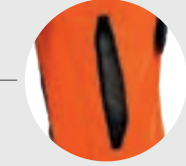

Vents on the back  
of the legs for additional  
breathability

EN 20471  
class 2EN 381-5  
class 1 20m/s

GLADIATOR



KlimaAIR



StretchAIR



3M ScotchLite

HUMIDITY  
MANAGEMENT

KWF

## Ventilation Chainsaw Protection Pants EN 20471

- Bright orange with reflective stripes according to EN 20471
- KlimaAIR® technology
- StretchAIR® technology
- Dyneema chainsaw protection class 1 and hi-vis protection class 2
- Removable gaiters
- Gladiator® fabric on the frontside
- Preformed knee reinforcement

The Ventilation Chainsaw Protection Pants in bright orange with reflective stripes according to EN 20471, are the perfect pants for application areas which require increased visibility. The high-quality Dyneema chainsaw protection guarantees the safety of the wearer of the pants. Gladiator® outer fabric for maximum tear resistance on the front. Maximum wear comfort is achieved through the KlimaAIR® and StretchAIR® technologies.

### Material:

Upper: 100 % PES  
Stretch fabric: 83 % EME lycra, 17 % PES T-400  
Lining: 100 % Cocona PES  
Chainsaw protection: Dyneema

### Sizes: (Special products possible)

XXS–XL, LS: XXL–3XL  
Large sizes + 10 % to 15 % surcharge



25 EN 20471

Item 101761 EN 20471 / Type A

short  
regular  
long

These items  
may also  
interest you:



P. 50



P. 56



P. 99

Scan the QR code to learn more  
about the proper care of the  
chainsaw protection products.



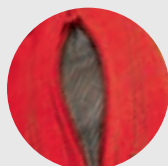

Ventilation slits  
on the back

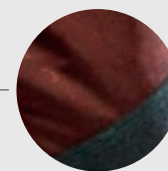

Proven Gladiator® Extreme  
fabric on the front of the thigh  
and lower leg, as well as in  
the heel area

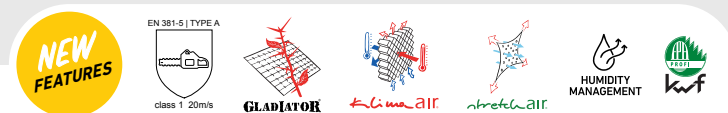

## Gladiator® Extreme Chainsaw Protection Pants

- StretchAIR® technology
- KlimaAIR® technology
- Gladiator® Extreme outer fabric
- Dyneema chainsaw protection class 1
- Vents on the backside
- Waterproof Keprotect® knee reinforcement
- Larger kidney protection

Gladiator® Extreme. The name says it all. These pants are made for the toughest challenges. Guaranteed 100 % no initial or continued tearing. Oil, heat, water or thorns do not challenge the outer fabric reinforced with Gladiator® Extreme yarns. These pants are the perfect armour for dense woods, overgrown with thorns. This exceptional high-tech leg protection, featuring KlimaAIR® and StretchAIR® technologies, guarantees maximum wear comfort.

### Material:

Gladiator® Extreme: 100 % polyamide  
Stretch fabric: 92 % polyamide, 8 % elastane  
Lining: 100 % Cocona PES  
Chainsaw protection: Dyneema

### Sizes: (Special products possible)

XS–XL, LS: XXL–3XL

Large sizes + 10 % to 15 % surcharge



Item 102192



These items  
may also  
interest you:



P. 146



P. 111



P. 57



P. 127



P. 166





FORESTRY



TREE CARE



KlimaAIR® technology  
guarantees maximum wear  
comfort and functionality

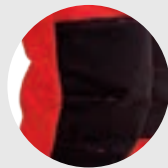

Waterproof knee  
reinforcements

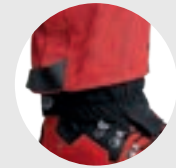

With removable  
gaiters



class 1 20m/s



100% MEMBRAN FREE

## Dyneema Arborist Chainsaw Protection Overall

- Full-length chainsaw protection class 1 up to the chest
- KlimaAIR® technology
- StretchAIR® technology
- Keprotec® knee- and inner-reinforcement
- Upper part adjustable with Velcro
- Removable gaiters

The lightweight Dyneema Chainsaw Protection Overall is specially designed for arborists that require Dyneema Chainsaw protection above the chest. With the elastic StretchAIR® fabrics and the body-hugging cut the carrier remains agile. The functionality is improved by the KlimaAIR® technology and the back is optimally protected against wind and weather throughout.

### Material:

Stretch fabric: 92 % polyamide, 8 % elastane  
Lining: 100 % Cocona PES  
Chainsaw protection: Dyneema

### Sizes: (Special products possible)

XS–XL, LS: XXL  
Large sizes + 10 % to 15 % surcharge



\* not in stock



40

Item 102182 Type A



These items  
may also  
interest you:



P. 193



P. 93



P. 123



P. 140



P. 155



FORESTRY



TREE CARE



Extra-large phone pocket

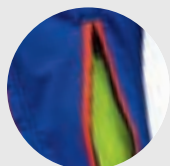

Ventilation zips for maximum temperature compensation



With removable gaiters (Type A only)



Extendable with zip-off suspenders



Extendable with Gladiator® suspenders

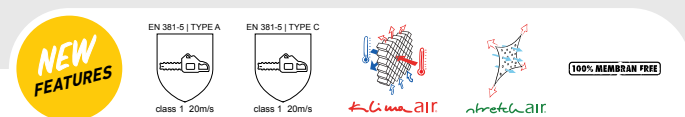

## Arborist Chainsaw Protection Pants Type A / Type C

- StretchAIR® technology
- KlimaAIR® around the waist
- Very light (Type A)
- Dyneema chainsaw protection class 1
- Gladiator® Extreme reinforcements protect the front and inside of the leg
- Removable gaiters (Type A only)
- Preformed knee part
- Cocona lining
- Reflective Paspol stripes

New cut redesigned to increase the freedom of movement with lower weight. The continuous ventilation fabric at the front prevents the accumulation of heat. The Arborist Chainsaw Protection Pants are adapted for climbing work. StretchAIR® and KlimaAIR® for unrestricted freedom of movement. Gladiator® Extreme reinforcements on the legs provide optimal protection.

The Type C pants are equipped with all-round chainsaw protection to protect the back of the legs from injuries.

### Material:

Stretch fabric: 92 % polyamide, 8 % elastane  
Knee reinforcement: 100 % polyamide  
Lining: 100 % Cocona PES  
Chainsaw protection: Dyneema

### Sizes: (Special products possible)

XS–XL, LS: XXL  
Large sizes + 10 % surcharge

Item 102218 Type A  
Item 106651 Type C



SlimFit



40

90

360S

361S



These items may also interest you:



P. 50



P. 155



P. 49



P. 95



P. 167



WORK PROTECTION



FORESTRY

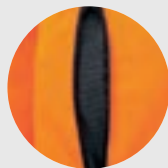

Vents on the back of the legs for extra breathability

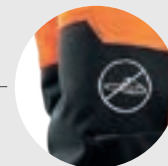
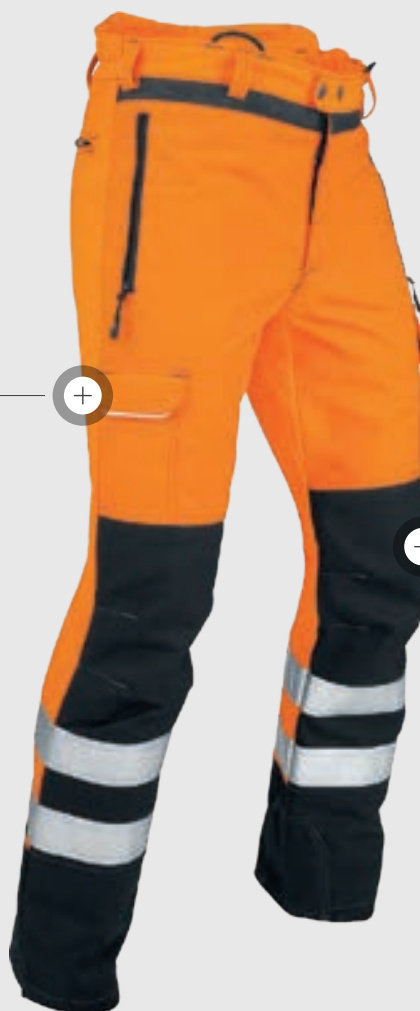

KlimaAIR® impact protection in the front area (no chainsaw protection)

NEW FEATURES



EN 20471 class 2

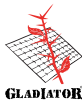

GLADIATOR

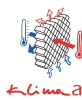

KlimaAIR

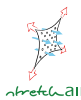

StretchAIR

3M ScotchLite



HUMIDITY MANAGEMENT

## Impact Clearing Saw Pants EN 20471

- StretchAIR® technology
- Gladiator® fabric on the front
- KlimaAIR® impact protection
- Ventilation insert at the waistband
- Vents on the back of the leg
- Gladiator® Extreme on the front and back of the leg
- EN 20471 class 2

Our experience in the forestry and outdoor areas are combined in these pants. The stretch fabric provides pleasant wearing comfort and StretchAIR® ensures maximum functionality. The pants are equipped with a special KlimaAIR® impact protection in the front area, which provides additional protection for the legs. The ventilation insert at the waistband and the vents on the back of the leg offer added breathability. Gladiator® Extreme on the front and back of the leg.

### Material:

Front: 100 % PES

Stretch fabric: 83 % EME lycra, 17 % PES T-400

### Sizes: (Special products possible)

XS–XL, LS: XXL–3XL

Large sizes + 10 % to 15 % surcharge

short  
regular  
long

25   
EN 20471

Item 101756



These items may also interest you:



P. 166



P. 191



P. 56



P. 145



P. 99





WORK PROTECTION



FORESTRY

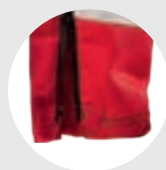

TREE CARE

Velcro fastener  
(Type A)Zipper  
(Type C)

EN 381-5 | TYPE A



class 1 20m/s

EN 381-5 | TYPE C



class 1 20m/s

100% MEMBRAN FREI

3M Scotchlite

## Chainsaw Protective Chaps Type A / Type C

- The Chaps can be put on over the pants without taking off the shoes
- Chainsaw protection class 1
- Waist and leg width adjustable with Velcro strap (Type A)
- Adjustable size with Zipp4Fit® (Type C)
- Reflective stripes

Our chainsaw protection solution for rapid deployment. The Chaps with chainsaw protection class 1 can be fitted in just 20 seconds and adjusted by means of a Velcro strap and a fastener. They are available as Type A with a Velcro fastener and Type C with a zipper. In Type C Chaps, the chainsaw protection overlaps the zipper and guarantees all-round chainsaw protection.

**Material:**

Upper: 65 % PES, 35 % cotton

Lining: 100 % PES

**Sizes:**

One size



40

FEUERWEHR

Reflective 'firefighters' label on the front of the thighs possible  
Item 100252

Item 804132 Type A

Item 106752 Type C



These items may also interest you:



P. 25



P. 191



P. 199



P. 125



P. 45

# CHAINSAW PROTECTION

## Type A

(dimensions in mm)

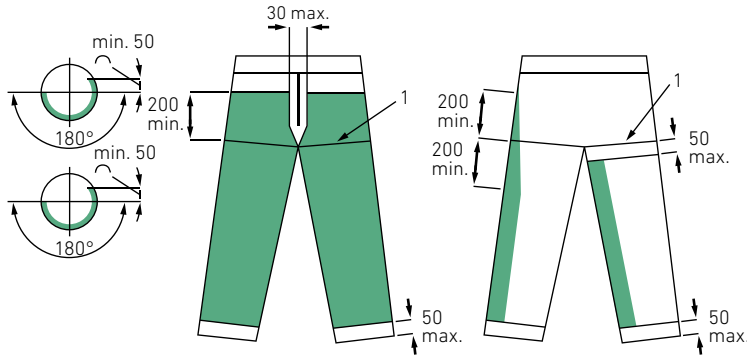
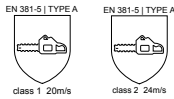

■ Protection area

Front

Back

## Type C

(dimensions in mm)

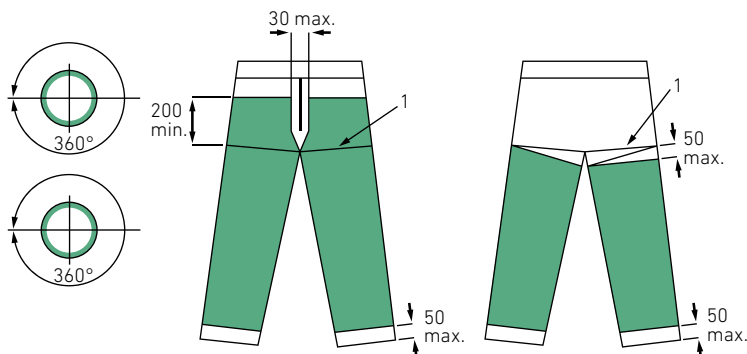

■ Protection area

Front

Back

## How does it work?

Chainsaw protection pants are protective clothing for working with a motor chainsaw and is intended to protect against injuries in the leg area. At the most vulnerable places in the front leg area, a layer of loosely woven, very long, fine, tear-resistant threads is integrated between the outer and inner pants materials from the ankle to the hip.

In case of contact, the chainsaw cuts the outer fabric and picks up the threads from the protective layer, which then wrap around the drive wheel of the chainsaw and block the machine in a split second.

In recent years, the European chainsaw protection standard EN 381 has been completely revised and adapted to the requirements of the times and current technologies. These revisions have been integrated into the new cut protection standard EN 11393. During the transition period, both standards remain valid and continue to offer the maximum safety with our products.

Chainsaw protection pants are defined by EN 381-5. There are two forms for the leg protection: The **Type A** is intended for professional chainsaw operators in conventional wood harvesting operations. The chainsaw protection is essentially limited to the front of the legs. The **Type C** is to be used by persons who are at risk of being injured by the chain saw on the back of the leg. **Type C** pants have the protection area on the front and back (enclosed protection).

**The chainsaw protection pants are divided into 4 classes:** Class 0: up to 16 m/s, Class 1: up to 20 m/s, Class 2: up to 24 m/s, Class 3: up to 28 m/s

In a central application test the KWF (Board of Forestry and Forestry technology) checks the application value of personal protective equipment. After a wearing time of one year the respective test persons assess the quality of the PPE with a specially developed questionnaire. The assessment includes the equipment, wearability, durability and wear resistance as well as the maintainability of the product.



Gladiator®

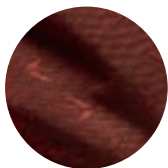

Gladiator® Extreme



FPA-approved

# ONLY CLEAN PANTS ARE **SAFE PANTS.**

## Washing instructions for chainsaw protection pants:

During use of the chainsaw protection pants sweat and oil regularly penetrates the layer of the chainsaw protection. This dirt agglutinates the fibres that ensure the chainsaw protection, and thus reduces the protective effect. In order to maintain the performance of the chainsaw protection, it is necessary to wash the pants properly on a regular basis. For daily use and average soiling, weekly cleaning cycles are recommended. If heavily soiled, wash immediately after wearing.

### Preparation

In the case of extreme soiling apply the Detergency Booster, optimally mixed 1:1 with water, directly on the stains using a spray bottle and, if possible, allow to react overnight in water. Then remove the stains with a hand brush and wash the clothes as usual.

### Machine wash

To ensure that the oil is removed from the washing machine, it is important to use liquid **colour detergent** and **not a heavy-duty detergent**.

Dose the colour detergent as usual. For 1 kg of dry laundry (a pair of chainsaw protection pants weighs 1.6 kg) add 10 ml of Detergency Booster in the detergent compartment for prewash.

### Attention

Start prewash at 40 °C and switch off the spin cycle!

**The chainsaw protection pants must not be put through spin cycles.** The spin cycle of a washing machine acts on the chainsaw protection of the pants like a milling action and compresses the fibres. This would significantly impair the chainsaw protection.

After washing, pull the pants into form and hang to dry.

**Under no circumstances put the chainsaw protection pants in the dryer.**

### Storage and Transport

The chainsaw protection pants should be stored in a well-ventilated and dry room. Extreme temperatures and contact with fluids or UV radiation (e.g. showcases) should be avoided.



You will find the Detergency Booster from PFANNER® and further care accessories for your protective clothing at P. 177.





VERSATILE AND  
FUNCTIONAL.





# FUNCTIONAL CLOTHING.

The right equipment is essential for demanding work or leisure activities. Our Functional Clothing keeps you warm, cool and dry. It stands out for its breathable, quick-drying and antibacterial fabrics that prevent unpleasant odours. High-tech, stretchy and easy-care materials guarantee maximum freedom of movement and unparalleled wearing comfort.

**With PFANNER® Functional Clothing, you will always be on the right track.**

<b>Upper body</b>	<b>92</b>
<b>Pants</b>	<b>109</b>



<b>Denise</b>	
PROTOS® Climber .....	189
PROTOS® Safety Glasses .....	198
PROTOS® Inuit Jacket Women .....	30
Globe Outdoor Pants .....	71
Brixen Trekking Shoe .....	121
<b>Alex</b>	
PROTOS® Climber .....	189
PROTOS® Safety Glasses .....	198
StretchAIR® Rain Jacket .....	47
Globe Outdoor Pants .....	71
Brixen Trekking Shoe .....	121

Person description from left to right.



WORK PROTECTION



FORESTRY



TREE CARE



HUNTING



OUTDOOR



MERINO

**Please note delivery time!**

Natural product with high demand for raw materials.



## Merino AirSoft Shirt

- Warming at low temperatures and cooling in hot weather
- Natural moisture management
- Anti-odour
- Reduces skin irritations
- Perforated fabric for maximum ventilation
- Pressure-free flatlock seams

The Merino AirSoft Shirt is the perfect solution for every skin type. Due to the perforated fabric, this shirt has exceptional insulation properties. With the merino wool, it is absolutely odour-resistant and self-cleaning. The flatlock seams guarantee a pressure-free wear under any clothing. Natural moisture management ensures a pleasant feeling on the skin.

**Material:**

99 % merino wool, 1 % spandex

**Sizes:**

XS–XL, LS: XXL–3XL

Large sizes + 10 % to 15 % surcharge



36



90

Item 107027



These items may also interest you:



P. 158



P. 111



P. 71



P. 51



P. 179





**Please note delivery time!**  
 Natural product with high demand for raw materials.



## Merino-Tencel™ Shirt

- Cools when hot and warms when cold
- Scratch-free merino wool
- Odour-inhibiting
- Absolutely skin irritation-free thanks to the Tencel™ inner
- Extra-long back
- Optimum moisture management
- Elastane for 100% dimensional stability
- Suitable for washing machines and non-iron

Tencel™, paired with merino wool, scores highly with its extraordinary moisture management properties. This fibre combination absorbs more water without the fabric feeling wet and effectively wicks moisture away from the body in an odour-inhibiting manner. The 3 % elastane guarantees dimensional stability. Due to the body-hugging, sporty cut the Merino-Tencel™ Shirt offers unrestricted freedom of movement.

**Material:**  
49 % Tencel™, 48 % merino, 3 % elastane

**Sizes:**  
XS–XL, LS: XXL–3XL  
Large sizes + 10 % to 15 % surcharge



Item 101737

  
 These items may also interest you:





WORK PROTECTION



FORESTRY



TREE CARE



OUTDOOR



## Vega Functional Shirt

- StretchAIR® technology
- 37.5 Cocona technology
- Pleasant, robust fabric, extremely dimensionally stable, colourfast and scrub-resistant
- Anti-odour
- Pressure- and scratch-free flatlock seams

The Vega Performance Shirt is the perfect equipment for strenuous activities. Its property to wick moisture away from the body makes it ideal for sweaty activities. Whether during sports or intense work, the Vega Functional Shirt keeps the skin dry and odour-free. The functional, close-fitting cut and the StretchAIR® technology guarantee unrestricted freedom of movement. Pressure-free seams provide scratch-free wearing. It remains colourfast at 100% and dimensionally stable even after hundreds of wash cycles.

**Material:**

100 % Cocona PES

**Sizes:**

XS–XL, LS: XXL–3XL

Large sizes + 10 % to 15 % surcharge



40

Item 106608



These items  
may also  
interest you:



P. 174



P. 68



P. 27



P. 120



P. 35



**Please note delivery time!**  
Natural product with high demand for raw materials.

MERINO

-   
WORK PROTECTION
-   
FORESTRY
-   
TREE CARE
-   
OUTDOOR



FUNCTIONAL







## Merino-Modal Shirt

- Extra warm in cold weather
- Fast drying
- Anti-odour
- Easy-care
- Functional cut
- Flatlock seams
- High-closing collar

**Material:**  
34 % merino wool, 43 % MicroModal, 23 % polyamide

**Sizes:**  
XS–XL, LS: XXL–4XL  
Large sizes + 10 % to 15 % surcharge



Item 101211

36  41 

## V-MATIC Hooded Shirt

- V-MATIC for maximum freedom of movement despite the hood
- Extremely scrub-resistant
- Armpit insert: perforated fabric made of 100 % merino wool
- Ideally combinable with PROTOS®
- Extra-long cut
- Very light

**Material:**  
38 % merino wool, 53 % nylon, 9 % spandex  
Armpit insert: 100 % merino wool

**Sizes:**  
XS–XL, LS: XXL–3XL  
Large sizes + 10 % to 15 % surcharge



Item 107017

36 



These items may also interest you:



P. 45



P. 25



P. 71



P. 132



P. 111









WORK PROTECTION



FORESTRY



TREE CARE



OUTDOOR



Practical Zipp2Zipp®  
pocket system

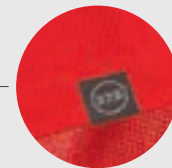

The 37.5 Cocona technology  
ensures a constant body  
temperature



Zipp2Zipp.



## Zip-Neck Shirt

- 37.5 Cocona technology
- StretchAIR® technology
- Odour and moisture management
- Lightweight
- Highly elastic
- Odourless
- 100 % colour fastness
- Zipp2Zipp® pocket system

Zip-Neck Shirt in neon colour – the top seller when it comes to the first layer on the skin. 37.5 stands for the constant body temperature of 37.5 °C even during peak physical performance. The fabric immediately wicks away excess moisture and heat, keeping body temperature constant. Odour particles are trapped and only released during washing. The material is odourless.

**Material:**  
100 % Cocona PES

**Sizes:**  
XS–XL, LS: XXL–4XL  
Large sizes + 10 % to 15 % surcharge



60

60

Item 104059 Short-sleeved  
Item 104060 Long-sleeved



These items  
may also  
interest you:



P. 51



P. 109



P. 107



P. 145



P. 25



WORK PROTECTION



FORESTRY



TREE CARE



HUNTING



OUTDOOR



## Zip-Neck Shirt

- 37.5 Cocona technology
- StretchAIR® technology
- Odour and moisture management
- Lightweight
- Highly elastic
- Odourless
- 100 % colour fastness

Thanks to the StretchAIR® technology, the Zip-Neck Shirt offers unrestricted freedom of movement and breathability for maximum wearing comfort. 37.5 stands for the constant body temperature of 37.5 °C, even during peak physical performance. The fabric immediately wicks away excess moisture and heat, keeping body temperature constant. Odour particles are trapped and only released during washing. The material is odourless.

### Material:

100 % Cocona PES

### Sizes:

XS–XL, LS: XXL–4XL

Large sizes + 10 % to 15 % surcharge



38



90

25   
EN 20471

38



90

25   
EN 20471

Item 104059 Short-sleeved

Item 104060 Long-sleeved



These items may also interest you:



P. 85



P. 164



P. 75



P. 22



P. 117





The chin protector provides a pleasant wear comfort

Odourless fabric



## Tencel™-Poly Zip-Neck Shirt EN 20471

- StretchAIR® technology
- Odour and moisture management
- Prevents skin irritation (Tencel™)
- High UV protection 40+
- Hi-Vis shirt certified to EN 20471 class 2

With EN 20471 certification, the Zip-Neck Shirt is ideally suited for work in road construction, air rescue or other areas where extremely good visibility is important. The StretchAIR® technology also guarantees maximum wearing comfort with unrestricted freedom of movement for the Tencel™-Poly Zip-Neck Shirt. It remains colour-fast at 100 % and dimensionally stable even after hundreds of wash cycles.

**Material:**  
 Outside: 100 % PES  
 Inside: 100 % Tencel™

**Sizes:**  
 XS–XL, LS: XXL–3XL  
 Large sizes + 10 % to 15 % surcharge



25 EN 20471

Item 104362

→  
 These items may also interest you:



P. 24



P. 26



P. 132



P. 75



P. 187



WORK PROTECTION



OUTDOOR



organic



STRETCHFLEX



organic

## PFANNER® Shirt 2-piece Set

- T-shirt, 165 g
- Excellent dimensional stability
- Shoulder-to-shoulder neckband
- Free of side seams
- PFANNER® logo on the right side

### Material:

Smoke: 85 % cotton, 15 % viscose  
Brilliant black: 80 % cotton, 20 % PES

### Sizes:

S–XL, LS: XXL–3XL  
Large sizes + 10 % to 15 % surcharge



Item 104371

## PROTOS® Shirt

- Functional shirt, 170 g
- Increased dimensional stability thanks to shoulder-to-shoulder neckband
- PROTOS® logo on left chest

### Material:

92 % cotton, 8 % elastane

### Sizes:

S–XL, LS: XXL–3XL  
Large sizes + 10 % to 15 % surcharge



47

Item 104373



These items  
may also  
interest you:



P. 179



P. 165



P. 121



P. 139



P. 140



## Holzer Tank Top 3-piece Set

- Dimensionally stable thanks to the shoulder-to-shoulder neckband
- Extra-long cut
- No side seams
- Holzer logo on left chest

Proven tank tops in a three-colour set, with the Holzer logo on the left chest. Ideal in summer or as an undershirt. Extra-long cut.

**Material:**  
 Forest green: 100 % cotton  
 Brilliant black: 80 % cotton, 20 % PES  
 Light grey: 99 % cotton, 1 % viscose

**Sizes:**  
 S-XXL, LS: 2XL  
 Large sizes + 10 % surcharge



Item 104359

→  
 These items may also interest you:









## Holzer Shirt 3-piece Set

- Dimensionally stable thanks to shoulder-to-shoulder neckband
- No side seams
- Extra-long cut
- Holzer logo on left chest

Improved proven T-shirts in a three-colour set, with the Holzer logo on the left chest. Also available separately without the Holzer logo.

**Material:**  
 Forest green: 100 % cotton  
 Brilliant black: 80 % cotton, 20 % PES  
 Light grey: 99 % cotton, 1 % viscose

**Sizes:**  
 S–XL, LS: XXL–3XL  
 Large sizes + 10 % to 15 % surcharge



Item 104370 3-piece set  
 Item 104372 One piece (without Holzer logo)

→  
 These items may also interest you:

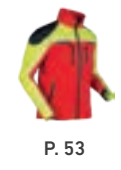





WORK PROTECTION



HUNTING



OUTDOOR



100% MEMBRAN FREE



100% MEMBRAN FREE



## Functional Polo Shirt

- 37.5 Cocona technology
- StretchAIR® technology
- Very good moisture wicking
- Quick-drying
- Antibacterial
- Durable and colourfast
- Integrated, jetted chest pocket

**Material:**

100 % Cocona PES

**Sizes:**

XS–XL, LS: XXL–3XL  
Large sizes + 10 % to 15 % surcharge



36

303



38

90

Item 100142

## PFANNER® Hooded T-shirt

- Extremely high dimensional stability
- Shoulder-to-shoulder neckband
- Highly elastic sleeve cuffs
- PFANNER® logo on the right side
- Easy care and colourfast
- Brilliant black

The PFANNER® Hooded T-shirt is the perfect complement for cool days.

**Material:**

80 % cotton, 20 % PES

**Sizes:**

S–XL, LS: XXL–3XL  
Large sizes + 10 % to 15 % surcharge



99

Item 104374



These items may also interest you:



P. 22



P. 62



P. 43



P. 121



P. 31



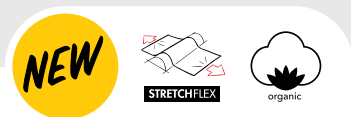

## Holzer 4-piece Set All Season

- The set includes a sweater, a T-shirt and a tank top all in a PFANNER® cotton bag
- Holzer logo printed in silver, bronze and gold
- Dimensional stability thanks to the shoulder-to-shoulder neckband
- T-shirt and tank top with no side seams

Special edition: all-year-round Fan-set with proven features.

### Material:

T-shirt and tank top: 80 % cotton, 20 % polyester  
Sweater: 72 % cotton, 20 % PES, 8 % elastane  
Bag: 100 % cotton

### Sizes:

S–XL, LS: XXL–3XL  
Large sizes + 10 % to 15 % surcharge



99 

Item 104390



These items may also interest you:



P. 33



P. 138



P. 61



P. 23



P. 164



WORK PROTECTION



FORESTRY



TREE CARE



OUTDOOR



100% MEMBRAN FREE



organic

## Quarter Zip-Neck Sweater

- Long sleeve sweater with napped inner
- 2×2 rib cuffs on hem and sleeves
- High collar with YKK zipper
- Elastane and shoulder-to-shoulder neckband for lasting dimensional stability

Quarter Zip-Neck Sweater – extra-long cut and close knitted for cool days. Warm and cosy high collar. High dimensional stability.

**Material:**

72 % cotton, 20 % PES,  
8 % elastane, 320 g/m<sup>2</sup>

**Sizes:**

XS–XL, LS: XXL–3XL  
Large sizes + 10 % to 15 % surcharge



99

Item 104379



These items  
may also  
interest you:



P. 120



P. 68



P. 178



P. 99



P. 29



Practical Zipp2Zipp®  
pocket system

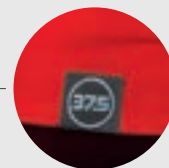

The 37.5 Cocona technology  
ensures a constant body  
temperature



Zipp2Zipp.



## Husky Shirt

- StretchAIR® technology
- 37.5 Cocona technology
- Zipp2Zipp® pocket system
- Stand-up collar with chin guard
- 100 % colourfast
- Does not scratch
- Very light and extra warm  
in cold weather
- Easy-care

The fleece shirt for cold days. The high collar does not only serve as warmth protection for the head and neck, but also prevents the penetration of dirt and small particles. 37.5 stands for the constant body temperature of 37.5 °C even during maximum physical performance.

**Material:**  
50 % Cocona PES, 50 % PES

**Sizes:**  
XS–XL, LS: XXL–4XL  
Large sizes + 10 % to 15 % surcharge



38

60

90

Item 101096



These items  
may also  
interest you:



P. 111



P. 149



P. 159



P. 109



P. 23





WORK PROTECTION



FORESTRY



TREE CARE



OUTDOOR

Gleichberechtigt  
LITR3-echtigung2Zipp.  
POCKET

## Skin-Dry Zipp2Zipp®

- StretchAIR® technology
- Soft flannel on the skin side
- Zipp2Zipp® pocket system
- Maximum moisture wicking
- Odour-inhibiting features
- Round neck design

**Material:**  
100 % PES

**Sizes:**  
XS–XL, LS: XXL–3XL  
Large sizes + 10 % to 15 % surcharge



44

51

Item 101387

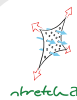

## Skin-Dry V-Neck

- StretchAIR® technology
- Soft flannel on the skin side
- Maximum moisture wicking
- Odour-inhibiting features
- V-Neck design

**Material:**  
100 % PES

**Sizes:**  
XS–XL, LS: XXL–3XL  
Large sizes + 10 % to 15 % surcharge



44

51

Item 101388



These items  
may also  
interest you:



P. 179



P. 148



P. 72



P. 84



P. 140



FUNCTIONAL



## Functional Shorts

- StretchAIR® technology
- Extremely elastic, lightweight
- Antibacterial, quick-drying
- Breathable and climate regulated
- Keeps the genital area dry, even under extreme temperatures

**Material:**  
95 % polyamide, 5 % elastane

**Sizes:**  
XS–XL, LS: XXL  
Large sizes + 10 % surcharge



40  90 

Item 804061

## Skin-Dry Functional Shorts

- StretchAIR® technology
- Combined all year shorts
- Ultra-high moisture wicking
- Optimum fit due to elastane
- Soft flannel on the skin side
- Flat seam

**Material:**  
100 % PES

**Sizes:**  
XS–XL



53 

Item 101479



These items may also interest you:



P. 61



P. 94



P. 95



P. 63



P. 140







**Please note delivery time!**  
Natural product with high demand for raw materials.



## Merino-Modal Thermal Pants

- Extra warm in cold weather
- Does not scratch, thanks to Modal on the skin side
- Odour and moisture management
- Suitable for washing machines

**Material:**  
43 % MicroModal, 34 % merino wool, 23 % polyamide

**Sizes:**  
XS–XL, LS: XXL  
Large sizes + 10 % surcharge



36 

## V-MATIC Thermal Pants / Thermal Shorts

- 100 % merino insert on the front of the thigh
- Ideal under chainsaw protection pants and tracking pants
- Very light, extremely scrub-resistant
- Warm at the back, cool in front
- Keeps you warm in the cold and cool in the heat
- Also suitable for ladies

**Material:**  
38 % merino wool, 53 % nylon, 9 % spandex  
Thigh insert: 100 % merino wool

**Sizes:**  
Unisex, XS–XL, LS: XXL  
Large sizes + 10 % surcharge



Item 107061 Pants  
Item 102413 Shorts

36  36 

Item 101165

→  
These items may also interest you:

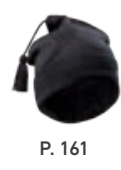



IT IS ALL ABOUT  
THE SHOE.







# OUR SHOES.

Whether for dangerous forestry work or tree care at dizzying heights. Whether for challenging trekking tours or extreme conditions on construction sites. It all depends on the shoe. You need a reliable companion that guarantees a secure grip on slippery or uneven terrains and protects you from injuries.

Many years of experience, expertise, the latest high-tech materials and high-quality manufacturing are our ingredients for extremely durable footwear, unsurpassed in functionality that stands up to any weather.

**Quality you can count on.**

<b>Work</b>	<b>114</b>
<b>Outdoor</b>	<b>120</b>
<b>Forestry</b>	<b>125</b>
<b>Insoles</b>	<b>139</b>
<b>Socks</b>	<b>140</b>



<b>Alexander</b>	
KlimaAIR® Forest Jacket .....	57
Ventilation Chainsaw Protection Pants .....	81
Zugspitze Extreme Class 2 Chainsaw Protection Boot .....	131





WORK PROTECTION



EN 20345 S3



NANOSHIELD

## Nanoshield® 840 S3

- Safety shoe EN 20345 S3
- Best moisture management, waterproof and breathable
- Puncture-proof steel sole, antistatic and resistant to oils and hydrocarbons
- Extra-thick and highly resilient PU cushioned sole
- Special outsole for fatigue-free walking
- Nanoshield® membrane with 4-layer construction
- Shoe height approx. 16 cm and weight approx. 0.8 kg per shoe in size 42

Nanoshield® 840 S3, the safety shoe for high demands. The high shaft protects the ankle and supports the ankle joint. The steel toe cap protects the forefoot; the steel sole is puncture-proof. Improved moisture management, together with ideal insulation against the cold, anatomical footbed and extra soft ankle protection ensure maximum comfort.

### Material:

Upper: cowhide leather  
Lining: Nanoshield®, polyamide  
Sole: 2D polyurethane

### Sizes:

39–46, LS: 47–48  
Large sizes + 10 % surcharge



36 ●

Item 100068



These items may also interest you:



P. 177



P. 140



P. 139



P. 63



P. 177



## Carbon Salzburg S3

- Safety shoe EN 20345 S3
- KlimaAIR® technology
- No foam, no moisture accumulation
- 3 mm thick cowhide leather
- Carbon rubble edge, multiple riveted
- Stainless copper chrome eyelets
- Strong grip, soot-free Vibram rubber sole
- Sole replacement possible
- Puncture-proof Kevlar insole
- Nano-Active Insole
- Extra high aluminium cap

Carbon Salzburg S3 – combines traditional craftsmanship with our KlimaAIR® technology. The shoe has a completely double-stitched frame. For this, two upper leathers are sewn together with a 3-fold sole construction. This design provides maximum comfort and is odour inhibiting. In addition, this design also allows a sole replacement. The lightweight aluminium cap protects the forefoot from external influences.

### Material:

Upper: cowhide leather  
Lining: PES KlimaAIR®  
Sole: all-terrain sole

### Sizes:

39–46, LS: 47–49  
Large sizes + 10 % surcharge



36 ●

Item 100032



These items may also interest you:



P. 172



P. 141



P. 61



P. 175



P. 187



WORK PROTECTION



&gt;&gt;&gt; 3CON &lt;&lt;&lt;&lt;

100% MEMBRAN FREE

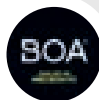

## BOA® Seguro Low S3

- BOA® Fit System
- Perfect one-hand handling
- Metal-free toe cap and sole
- TPU toe protection reinforcement
- Minimal sole wear
- Heel reinforcement
- Leather upper against hot chippings and welding spatter
- Self-cleaning profile
- 3CON® Reflex for enhanced visibility

The BOA® Seguro Low S3 is a lightweight and sturdy safety shoe. The patented BOA® twist closure allows quick and easy putting on and taking off, as well as a perfect fit of the shoe thanks to the precise adjustment of the laces. Reinforced heel for maximum form stability. Increased visibility is ensured by the processed 3CON® technology. Continuous leather upper provides protection against hot chippings and welding spatter. Wear-free eyelets and laces ensure the durability of the shoe. The breather fabric stands for comfortable wearing properties. The soot-free Vibram TPU sole guarantees highest grip and abrasion resistance.

### Material:

Upper: leather  
Lining: mesh fabric  
Sole: Vibram TPU rubber sole

### Sizes:

36–46, LS: 47–48  
Large sizes + 10 % surcharge



11

Item 102334



These items  
may also  
interest you:



P. 61



P. 100



P. 38



P. 145



P. 178





sympatex®



## BOA® Seguro High S3

- BOA® Fit System
- Perfect one-hand handling for quick on and off
- VSS (Vario Support System) in the heel area
- Sympatex lining for highest water resistance
- TPU toe protection reinforcement
- Ankle protection
- Self-cleaning profile
- 3CON® Reflex for enhanced visibility

The high shaft of the BOA® Seguro High S3 protects the ankle and supports the ankle joint. Continuous leather upper provides protection from hot chippings and welding beads. Improved visibility due to the processed 3CON® technology. Wear-free eyelets ensure the durability of the shoe. Breathable fabric for best moisture management and comfort. Highest grip and scrub-resistance is guaranteed by the soot-free Vibram TPU sole.

### Material:

Upper: leather  
Lining: mesh fabric  
Sole: Vibram TPU rubber sole

### Sizes:

36–46, LS: 47–48  
Large sizes + 10 % surcharge



11

Item 102332



These items may also interest you:



P. 178



P. 94



P. 187



P. 165



P. 175







WORK PROTECTION

**CORDURA**  
FABRIC

sympatex®



## BOA® Work S3

- BOA® Fit System
- Rubble protection and upper material continuously riveted together
- EN 20345 S3 certified
- Metal-free toe cap and sole
- Robust rubble edge and toe protection
- Oil and acid resistant all-terrain sole
- Upper made of 100% cowhide – 2.2 mm thick, suitable for welding and grinding work
- Weight: 0.92 kg per shoe, size 42

The patented BOA® twist closure allows fast and easy putting on and taking off as well as precise adjustment of the laces. The high shaft of the BOA® Work S3 protects the ankle and supports the ankle joint. Continuous leather uppers provide protection from hot chippings and welding beads. The BOA® closures, shoe eyelets and laces withstand concrete, rain, ice and freezing temperatures. Breathable fabric provides the best moisture management and comfortable wearing. The all-terrain sole ensures maximum grip on the terrain.

**Material:**  
Upper: leather, Cordura  
Lining: Sympatex  
Sole: Vibram

**Sizes:**  
39–46, LS: 47–48  
Large sizes + 10% surcharge



14

Item 102338



These items may also interest you:



P. 147



P. 140



P. 100



P. 62



P. 31





HUNTING



OUTDOOR



sympatex®



## Zenith STX Mountaineering Boot

- Sympatex membrane
- Very light
- Proven Vibram sole
- Rubber rubble protection in the front and rear foot areas
- Nubuck leather
- Damping EVA midsole
- Anti-torsion sole design
- Nano-Active Insole for a cushioning walking feel

The Zenith STX Mountaineering Boot is the perfect equipment for long tours. Lightweight, with excellent rolling characteristics. The Vibram sole guarantees the best grip. The EVA midsole dampens every step. Extra-long lacing allows for a perfect fit and hold of the shoe. The nubuck leather is durable and easy to care for.

### Material:

Upper: nubuck leather

Lining: PES

Sole: Vibram

### Sizes:

39–46, LS: 47

Large sizes + 10 % surcharge



19

Item 102293



These items  
may also  
interest you:



P. 177



P. 179



P. 171



P. 174



P. 92



Brixen Trekking Shoe

Brixen Advanced Trekking Shoe

100% MEMBRAN FREE



## Brixen (Advanced) Trekking Shoe

- Perfect hold thanks to extra-long lacing and rubber heel reinforcement
- Anti-torsion sole design with Vibram sole
- Continuous shock absorbing midsole
- Rubber rubble protection
- Continuously sewn tongue
- 100 % MembranFREE for highest breathability

Ergonomic cut and extended lacing for a perfect hold in the shoe. The Nano-Active Insole provides a cushioning feel when walking. In combination with the 100 % MembraneFREE technology the Brixen and the Brixen Advanced have the highest level of functionality. The sole construction is multi-layered and torsion-free. With its Vibram profile sole, the Brixen Trekking Shoe is the perfect lightweight shoe for the outdoors.

### Material:

Upper: full-grain leather  
 Upper Advanced: old leather  
 Lining: calfskin and 3D mesh  
 Sole: Vibram

### Sizes:

36–46, LS: 47–48  
 Advanced: 38–46, LS: 47–48  
 Large sizes + 10 % surcharge

Item 106976

Item 102412 Advanced



90 ●



36 ●



These items may also interest you:



P. 139



P. 172



P. 71



P. 140



P. 109









TREE CARE



OUTDOOR



Integrated tabs to attach the VerticalLoop for climbing ascenders

**NEW**

sympatex®



EXTREMELY LIGHT

## Arborist STX Vertical

- Rubble protection
- VerticalLoop for climbing ascenders
- Lightweight shoe (645 g/boot in size 43)
- Absorbent Vibram Light sole
- Sympatex membrane
- 2.6 mm Perwanger leather

When it comes to vertical climbing, every unnecessary gram of gear is too much. With its light weight of 645 g/boot in size 43, the Arborist STX Vertical convinces. For countless uses and leisure activities, the lightweight Vibram sole ensures a secure stand and the Nano-Active Insole provides a cushioning feel when walking. The replaceable VerticalLoop eliminates the need for a tread sling and therefore the climbing clamp can be easily attached to the boot. The 2.6 mm water-repellent Perwanger leather and the Sympatex membrane withstand all weather conditions.

### Material:

Upper: Perwanger leather  
Lining: Sympatex  
Sole: Vibram

### Sizes:

38–46, LS: 47–48  
Large sizes + 10 % surcharge



9

Item 104310



These items may also interest you:



P. 193



P. 85



P. 173



P. 141



P. 174



HUNTING



OUTDOOR



sympatex®



## Sirius STX Mountaineering Boot

- Sympatex membrane
- Stainless copper chrome eyelets
- PU cushioning element in the heel area
- 2-split lacing system for a perfect fit
- Rubber rubble protection on the carbon-fibre reinforcement
- Suitable for crampons

The Sirius STX Mountaineering Boot is the first choice for demanding mountain tours. The high-grip Vibram profile provides secure grip on alpine terrain. The nubuck leather is stretchable, but nevertheless exhibits shape-retention. The ankle support and bipartite lacing make for the perfect fit. The PU cushioning insert ensures excellent walking comfort. Thanks to the Sympatex membrane, the shoe is waterproof and breathable. The Sirius STX is also suitable for crampons.

**Material:**

Upper: nubuck leather  
Lining: PES  
Sole: Vibram

**Sizes:**

39–46, LS: 47–48  
Large sizes + 10 % surcharge



11

Item 102292



These items  
may also  
interest you:



P. 172



P. 141



P. 107



P. 130



P. 179



WORK PROTECTION



FORESTRY



TREE CARE

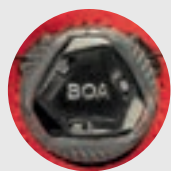

Quick to put on  
and take off with  
BOA® Fit System

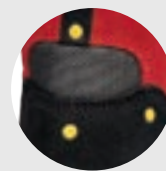

Rubble protection, upper  
material and chainsaw protection  
continuously riveted together

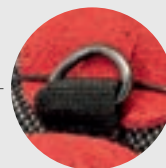

Gaiter loops

CORDURA  
FABRIC

sympatex®



## BOA® Class 2 Chainsaw Protection Boot

- Perfect fit due to double BOA® Fit System
- The lightest class 2 chainsaw boot, less than 1 kg at EU shoe size 41
- Rubble protection, upper material and chainsaw protection continuously riveted together
- Metal-free toe cap and sole
- EN 20345 S3 and EN 17249 certified
- Waterproof Sympatex membrane
- Additional reinforced rubble edge
- Extremely high shaft, 27 cm at EU shoe size 43

The lightest of the class 2 chainsaw protection boot, under 1 kg at size 41. The double Boa® Fit System impresses with its precise, safe fit, and quick on and off and/or loosening for ventilation and pressure relief. The closures withstand concrete, rain, ice and freezing temperatures. The PFANNER® patented chainsaw protection and the extended, wave-shaped rubble protection, make the boot immediately recognisable as a chainsaw protection boot (optical image of a saw chain, yellow rivets for chainsaw protection class 2).

### Material:

Upper: leather, Cordura  
Lining: Sympatex  
Sole: Vibram

### Sizes:

39–46, LS: 47–48  
Large sizes + 10 % surcharge

Rubble protection, upper material and chainsaw protection continuously riveted together so that the chainsaw protection does not slip when walking. All-terrain puncture-proof Vibram sole with Kevlar, protective composite toe cap, TPU toe protection. The boot is suitable for all tasks such as carpenter, welder, steel-worker, etc. – the laces cannot burn.



16

Item 102337



These items  
may also  
interest you:



P. 85



P. 151



P. 136



P. 159



P. 173





FORESTRY



TREE CARE

EN 17249  
class 1 20m/s

EN 20345 S3



## Zermatt GTX Class 1 Chainsaw Protection Boot

- Chainsaw protection class 1
- Strong grip Vibram alpine sole
- Aluminium protection cap
- Cordura inner lining
- Very light
- Puncture-proof
- GORE-TEX membrane

Long and challenging missions in the forest or during tree care in difficult terrain require a shoe that protects the foot and provides maximum grip and great mobility. All these features are combined in the Zermatt GTX Chainsaw Protection Boot. The chainsaw protection class 1 and aluminium protection cap guarantee safety. The Vibram sole with mountain profile ensures a perfect stand. Thanks to the GORE-TEX membrane, the shoe is waterproof and breathable. Scrub-resistant Cordura inner lining and riveted seams guarantee the longevity of the Zermatt GTX.

### Material:

Upper: Perwanger leather  
Lining: polyamide Cordura  
Sole: Vibram

### Sizes:

39–46, LS: 47–48  
Large sizes + 10 % surcharge



16

Item 100234



These items  
may also  
interest you:



P. 139



P. 97



P. 177



P. 172



P. 173



FORESTRY



TREE CARE

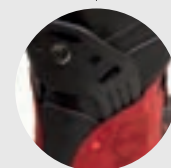

Patented Vario Support System (VSS)



EN 17249  
class 2 24mm



## Matterhorn Class 2 Chainsaw Protection Boot

- EN 17249 chainsaw protection class 2
- Ceramic stud reinforced surface
- Aluminium protective toe cap
- VSS (Vario Support System) exchangeable in the heel area
- Best grip Vibram alpine sole
- Narrow tread for effortless walking
- Multiple riveted double seams reinforced with rubber rubble edge
- Shock-absorbing midsole

Item 106835

Item 104235 VSS (Vario Support System)

The unique VSS in the heel area provides maximum stability. The narrow outer sole makes it possible to walk with minimum effort. The VSS splint system protects the ligaments and prevents sprains, especially when descending steep terrains. The VSS insert can be removed for flat surfaces and when driving machines and vehicles. Multiple rivets at the areas susceptible to scrub and abrasion prevent wear of the double seams. Ball eyelets facilitate the lacing of the boot and prevent wear. The Matterhorn Chainsaw Protection Boot is equipped with a GORE-TEX membrane. The Nano-Active Insole provides a cushioning feel when walking.

**Material:**

Upper: leather/micro-fibre, ceramic  
Lining: polyamide Cordura  
Sole: Vibram

**Sizes:**

39–46, LS: 47–48

Large sizes + 10 % surcharge



16



36



These items may also interest you:



P. 136



P. 191



P. 57



P. 111



P. 172









FORESTRY



TREE CARE

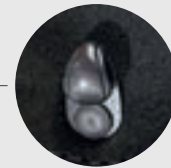

Hooked eyelets to securely fix the tongue

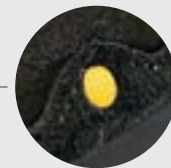

Chainsaw protection classes marked by coloured rivets (yellow = chainsaw protection class 2)



sympatex®



## Pilatus Class 2 Chainsaw Protection Boot

- Rubble protection, upper material and chainsaw protection all riveted together in a continuous wave from top to bottom
- EN 17249 chainsaw protection class 2
- EN 20345 S3 certified
- Aluminium protective toe cap
- Rubber rubble protection
- Round eyelets/rivet eyelets
- Shock-absorbing Vibram sole
- Sympatex membrane / Cordura lining
- New: Hard rubber heel reinforcement

The Pilatus Chainsaw Protection Boot stands out with its patented rivets, which stably connect the upper material, the chainsaw protection and the rubble protection. The PFANNER® patented chainsaw protection and the heightened wave-shaped rubble protection, make the boot immediately recognisable as a chainsaw protection boot (yellow rivets mean chainsaw protection class 2). Equipped with an aluminium protective cap, the shoe is a faithful companion both in the forest and on the construction site.

**Material:**  
Upper: leather  
Lining: Sympatex, Cordura  
Sole: Vibram

**Sizes:**  
37–46, LS: 47–48  
Large sizes + 10 % surcharge

This all-rounder with waterproof Sympatex membrane and Cordura lining is ideally suited for a wide range of uses in any weather. The rivet eyelets do not damage the ropes, making these boots also suitable for climbing. The heel reinforcement provides 100 % protection from chafing.



36 ●

Item 104328



These items may also interest you:



P. 53



P. 93



P. 140



P. 172



P. 23



FORESTRY



TREE CARE

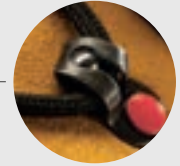

Ball bearing shoe eyelets protect the lace from wear and tear



sympatex®



## Zugspitze Alpine Class 2 Chainsaw Protection Boot

- Rubble protection, upper material and chainsaw protection continuously riveted together
- EN 17249 chainsaw protection class 2 and EN 20345 S3 certified
- KlimaAIR® spacer lining
- Ankle protection and aluminium toe cap
- Sympatex membrane and PUTEK® shaft padding
- 2.6 mm Perwanger leather and non-flexible ball bearing eyelets
- Absorbent Vibram light sole

Alpine all-rounder for flat to steep terrain. The Zugspitze Alpine Chainsaw Protection Boot, with PFANNER® patented chainsaw protection and heightened wave-shaped rubble protection, which makes the boot immediately recognisable as a chainsaw protection boot (optical image of a saw chain, yellow rivets mean chainsaw protection class 2). The 2.6 mm water-repellent Perwanger leather and the Sympatex membrane withstand all weather conditions.

### Material:

Upper: Perwanger leather, PUTEK®  
Lining: Sympatex  
Sole: Vibram

### Sizes:

39–46, LS: 47–49  
Large sizes + 10 % surcharge

With a weight of approx. 1.3 kg/boot in size 43 and the self-cleaning Vibram Light sole, the Zugspitze Alpine impresses with its maximum comfort. The patented KlimaAir® fabric in combination with the PUTEK® shaft padding ensures a maximum ventilation, a soft shaft edge and a fine finish.



9

Item 104330



These items may also interest you:



P. 57



P. 81



P. 169



P. 191



P. 173



FORESTRY



TREE CARE



Piz Buin fitting for the most extreme of terrains, holds even on rock, wet tree trunks and ice



Version with crampon made of stainless steel for best grip on slippery surfaces



sympatex®



## Zugspitze Extreme Class 2 Chainsaw Protection Boot

- Rubble protection, upper material and chainsaw protection continuously riveted together
- EN 17249 chainsaw protection class 2 and EN 20345 S3 certified
- KlimaAIR® spacer lining
- Ankle protection and aluminium toe cap
- Sympatex membrane and PUTEK® shaft padding
- Suitable for all crampons
- KWF professional tested

Sensational combination of a high-tech mountain boot with PFANNER® patented chainsaw protection and heightened wave-shaped rubble protection. The Zugspitze Extreme Chainsaw Protection Boot is ready for all extreme missions. The 2.6 mm water-repellent Perwanger leather and the Sympatex membrane withstand all weather conditions. The all-terrain Vibram sole provides extreme grip and tread resistance on all terrain, and is especially suitable for all crampons.

**Material:**  
Upper: Perwanger leather, PUTEK®  
Lining: Sympatex  
Sole: Vibram

**Sizes:**  
39–46, LS: 47–49  
Large sizes + 10 % surcharge

The patented KlimaAir® fabric in combination with the PUTEK® shaft padding ensures a maximum ventilation, a soft shaft edge and a fine finish.



- Item 104340
- Item 104341 Zugspitze Extreme incl. Piz Buin
- Item 104342 Zugspitze Extreme incl. crampon



These items may also interest you:



P. 51



P. 141



P. 177



P. 53



P. 139





FORESTRY



TREE CARE

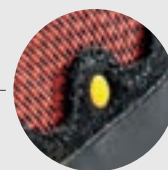

Rubble protection, upper material and chainsaw protection continuously riveted together



sympatex®



## Sántis Class 2 Chainsaw Protection Boot

- Rubble protection, upper material and chainsaw protection continuously riveted together
- EN 17249 chainsaw protection class 2
- Protective aluminium toe cap
- Ball bearing eyelets
- Crampon resistant
- Seamless, maintenance-free surface
- Shock-absorbing Vibram sole
- Sympatex membrane / Cordura lining
- New: Hard rubber heel reinforcement

The Sántis Chainsaw Protection Boot stands out with its patented rivets, which stably connect the upper material, the chainsaw protection and the rubble protection. The PFANNER® patented chainsaw protection and the heightened wave-shaped rubble protection, make the boot immediately recognisable as a chainsaw protection boot (yellow rivets mean chainsaw protection class 2). This boot stands out for its ceramic surface, which makes it extremely dirt-repellent and easy to clean.

### Material:

Upper: PUTEK®  
Lining: Sympatex, Cordura  
Sole: Vibram

### Sizes:

39–46, LS: 47–48  
Large sizes + 10 % surcharge

The special, breathable lining made of Cordura and Sympatex ensures a comfortable and dry wearing experience throughout the entire working day. The heel reinforcement provides 100% protection from chafing.



16

Item 104327



These items may also interest you:



P. 85



P. 51



P. 136



P. 191



P. 103



FORESTRY



TREE CARE

EN 17249  
class 1 2019s

## Tyrol Fighter Class 1 Chainsaw Protection Boot

- 3 mm thick military leather
- True doublestitch
- Single seam, 3-times-sewn and 3-times riveted
- Wear comfort thanks to the KlimaAIR® technology
- Stainless steel eyelets
- 6-layer sole assembly
- Chainsaw protection class 1
- Soft and flexible wear
- Extra-high protective aluminium toe cap

The traditional one: with 3 mm thick and extremely robust military leather, the Tyrol Fighter is soft and smooth to wear. The patented KlimaAIR® technology prevents the accumulation of heat in the boots. The puncture-proof sole and chainsaw protection class 1 ensure protection against cut injuries.

### Material:

Upper: military leather  
Lining: PES KlimaAIR®  
Sole: Vibram

### Sizes: (Special products possible)

36–46, LS: 47–52  
Large sizes + 10 % to 15 % surcharge



36 ●

Piz Buin Low  
Fitting

Item 103185

Item 100964 Piz Buin Low incl. screws



These items  
may also  
interest you:



P. 173



P. 177



P. 177

Learn everything about the  
proper care of your PFANNER®  
shoes by scanning the QR code.











FORESTRY



TREE CARE



## Tyrol Juchten Class 1 Chainsaw Protection Boot

- 5 mm thick Juchten leather
- True doublestich
- Single seam, 3-times-sewn and 3-times riveted
- KlimaAIR® technology
- Stainless copper-chrome eyelets
- 6-layer sole assembly
- Chainsaw protection class 1
- Extremely robust
- Extra-high protective aluminium toe cap

Item 103177

Item 100457 Extra wide

Item 100964 Piz Buin Low incl. screws

Almost unchanged, we still offer this shoes, decades after it was first part of the range. The KlimaAIR® technology ensures the air circulation in the shoes, thus optimizing the wear comfort. The stainless copper-chrome eyes and the 3-times riveted out-seam guarantee the durability of the shoes. The new 5 mm thick Juchten leather and the chainsaw protection class 1 protect the foot against cut injuries. The proven design and quality remain unique.

### Material:

Upper: Juchten leather

Lining: PES KlimaAIR®

Sole: Vibram

### Sizes: (Special products possible)

36–46, LS: 47–54

Large sizes + 10 % to 15 % surcharge



26 ●

Piz Buin Low  
Fitting



These items  
may also  
interest you:



P. 136



P. 172



P. 136

Learn everything about the  
proper care of your PFANNER®  
shoes by scanning the QR code.





Fitting to the profile sole only possible with the Piz Buin Low

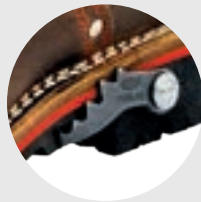
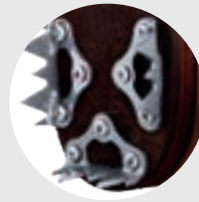
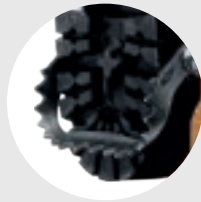

Piz Buin High Fitting



Piz Buin Low Fitting

## Tyrol Juchten including crampon

- Tyrol Juchten Class 1 Chainsaw Protection Boot (see page 135)
- Crampon made of stainless steel
- Best grip on slippery surfaces
- Foldable for easy terrain

### Sizes:

Crampon available up to shoe size 48.

### Item 103190

Tyrol Juchten incl. crampon

## Tyrol Juchten including fittings Piz Buin

- Tyrol Juchten Class 1 Chainsaw Protection Boot (see page 135)
- Stainless steel fittings
- For the most extreme of terrains, holds even on rock, wet tree trunks and ice
- 100% corrosion-free stainless steel
- Very high abrasion resistance

### Item 103187

Tyrol Juchten incl. Piz Buin

## Fittings Piz Buin

- Stainless steel fittings with approx. 2 cm (Piz Buin High) or approx. 1.5 cm (Piz Buin Low) high tips
- For the most extreme of terrains, holds even on rock, wet tree trunks and ice
- 100% corrosion-free stainless steel
- Very high abrasion resistance

### Item 100963

1 pcs. Piz Buin High incl. screws

### Item 100964

1 pcs. Piz Buin Low incl. screws



These items may also interest you:



P. 146



P. 191



P. 57



P. 111



P. 172



FORESTRY



TREE CARE

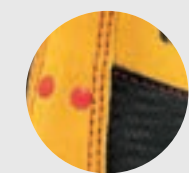

Reinforced, additionally riveted heel seam

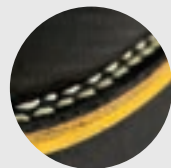

Double stitched shoe sole

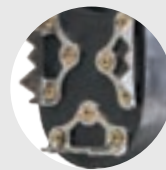
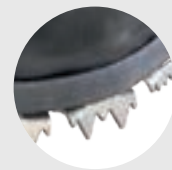

Piz Buin fitting for the most extreme of terrains, holds even on rock, wet tree trunks and ice

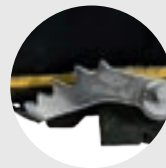
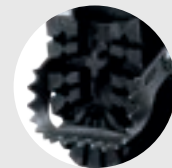

Version with crampon made of stainless steel for best grip on slippery surfaces

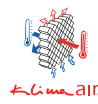

## Tyrol Gladiator® Class 1 Chainsaw Protection Boot

- Carbon rubble protection, upper material and chainsaw protection continuously riveted together
- EN 17249 chainsaw protection class 1 and EN 20345
- KlimaAIR® spacer lining
- Non-flexible ball bearing eyelets
- 3 mm thick Perwanger leather
- Genuine double stitched
- 6-layer sole construction
- Extra-high protective aluminium toe cap

Further development of Fighter and Juchten. Tyrol Gladiator® with PFANNER® patented chainsaw protection and heightened wave-shaped rubble protection, which makes the boot immediately recognisable as a chainsaw protection boot (optical image of a saw chain, red rivets chainsaw protection class 1). Water-repellent, 3 mm thick Perwanger leather, comfortable to wear and does not need to be worn in.

### Material:

Upper: Perwanger leather  
Lining: PES KlimaAIR®  
Sole: Vibram

### Sizes:

41–46, LS: 47–48  
Large sizes + 10 % surcharge

Extra high full leather shaft with KlimaAIR® fabric for optimal protection, support and ventilation. The robust carbon rubble edge provides additional protection and strength for the upper material. With a low weight of 1.4 kg/boot in size 43, the Gladiator® fits perfectly into the PFANNER® model series Tyrol.



9

Item 103160

Item 103161 Tyrol Gladiator® incl. Piz Buin

Item 103162 Tyrol Gladiator® incl. crampon



These items may also interest you:



P. 50



P. 69



P. 136



P. 107



P. 105





WORK PROTECTION



HUNTING



EN 20345 S5



THERMO



EXTREMELY LIGHT

## Bekina Boots Steplite® XCi S5

- EN 20345 S5
- Lightweight and robust
- Guaranteed warm feet down to -40 °C
- Year-round use
- 100 % waterproof and flexible material
- Absolutely metal-free
- Shock-absorbing heel
- Optimum grip due to self-cleaning profile
- Ergonomic insole
- Variable shaft heights possible

No more cold feet with Steplite® XCi cold insulation down to -40 °C. The Bekina safety boot with metal-free sole and safety toe cap. Thanks to the materials used, the boots are lighter, safer and warmer. The anatomically shaped insole offers maximum wearing comfort. Steplite® XCi S5 is recommended as a boot for all seasons.

**Material:**

Upper: soft polyurethane  
Sole: polyurethane

**Sizes:**

37–46, LS: 47–48  
Large sizes + 10 % surcharge



38 ●

Item 104307



These items may also interest you:



P. 73



P. 162



P. 45





P. 150



P. 107

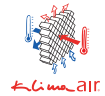

## Nano-Active Insoles

- KlimaAIR® honeycomb structure
- Nano-Active structure
- Dries 5 times faster than leather
- Extremely scrub-resistant
- Light as feather
- Shape adaptation possible
- Extremely thin in the toe area

The new Nano-Active technology eliminates 100 % of the distribution of bacteria and odours on the soles. The honeycomb structure on the middle and rear foot provides optimal pressure distribution. The Nano-Active Insoles are lightweight, cushioning and yet extremely scrub-resistant and durable.

**Material:**  
 Sole area: micro-fibre  
 Damping: EVA  
  
**Sizes:**  
 36-48



36 ●●

Item 102366

→  
These items may also interest you:





WORK PROTECTION



FORESTRY



TREE CARE



HUNTING



OUTDOOR



Modal

100% MEMBRAN FREE

## EcoTec Low Functional Socks

- High breathability and moisture management
- Highest wear comfort through Modal terry cloth
- Cosy, cushioning terry cloth inside the heel and sole areas
- Rubber-free endings with 1×1 knitted fabric
- High scrub-resistance and dimensional stability
- Antibacterial

A refined and coordinated mix of materials for improved function and shape retention. The cushioning terry inner prevents chafing of the heel and sole of the foot.

**Material:**

45 % Modal, 45 % polyamide, 10 % Lycra

**Sizes:**

38–40, 41–43, 44–46, 47–49

Item 101220



Modal

100% MEMBRAN FREE

## Outdoor Light Functional Socks

- High breathability
- Highest wear comfort through Modal wool
- Shock-absorbing effect
- Lower mesh density at the top

The wear comfort has improved once again due to switching to Modal wool. The low mesh density at the back of the foot ensures optimum evaporation for the foot. The pressure-free seams prevent chafing of the toes even on long excursions. The Lycra fibre give the socks an optimal fit.

**Material:**

62 % Modal, 37 % polyamide, 1 % Lycra

**Sizes:**

38–40, 41–43, 44–46, 47–49

Item 101210



These items may also interest you:



P. 95



P. 173



P. 39



P. 175



P. 129





**Please note delivery time!**  
 Natural product with high demand for raw materials.

  
**SEASONAL PRODUCTS**

**NEW**  
 100% MEMBRAN FREE  
  MERINO

100% MEMBRAN FREE  
  MERINO

## Outdoor EcoDry Functional Socks

- Two layer knit structure
- Inner layer of merino terry
- Outer layer made of polyamide
- Shock-absorbing effect, protection against chafing on heel and sole of foot
- 1×1 knitted shaft
- Ideal for shoes with a high shaft

Outdoor EcoDry Functional Socks: designed to keep your feet warm and dry in changing weather. These socks combine natural warmth with enhanced breathability and drying properties.

**Material:**  
 72 % merino EcoDry, 26 % polyamide, 2 % elastane

**Sizes:**  
 38-40, 41-43, 44-46, 47-49

Item 101230

## Merino Thermal Socks

- High-quality merino wool, especially for cold temperatures
- Heels and toes reinforced additionally
- Shock-absorbing effect
- Thin instep

We have changed the manufacture of these socks to a 100-year-old knitting method. This increases the wear comfort through the airy structure and ensures an incomparable feel when walking. The merino wool does not absorb any odours and offers optimal insulating capability. The reinforced heel and toe areas make the wear points even more durable.

**Material:**  
 68 % merino wool, 27 % polyamide, 5 % Lycra

**Sizes:**  
 38-40, 41-43, 44-46, 47-49

Item 101240



These items may also interest you:



P. 163



P. 125



P. 139



P. 153



P. 121



ALL UNDER  
CONTROL.



# OUR GLOVES.

Warm, dry hands and a perfect comfort with optimum grip in any kind of weather – that's what good work gloves are about. Different surface coatings and reinforced palms protect your hands to the utmost and ensure durability. The StretchFlex® technology guarantees form stability, high breathability and a perfect fit.

**Ready to grab.**

<b>Work</b>	<b>144</b>
<b>Thermal</b>	<b>149</b>
<b>Standards and size chart</b>	<b>154</b>
<b>Chainsaw protection</b>	<b>155</b>



<b>Bernhard</b>	
PROTOS® Arborist .....	193
PROTOS® Neck Protector .....	199
Merino-Modal Shirt .....	95
PROTOS® Inuit Teddy Vest .....	34
StretchFlex® Fine Grip .....	145
Arborist Chainsaw Protection Pants .....	85
Arborist STX Vertical .....	123





WORK PROTECTION



FORESTRY



TREE CARE



OUTDOOR



## StretchFlex® HPT® Cut D

- Cut protection class D (level 4) according to the new standards
- HPT® (Hydrepellent Technology) = water-repellent coating
- All-round cut protection
- PES steel polyamide knit
- StretchFlex® technology
- Antibacterial Sanitized
- Very good tactile sensitivity and grip
- Highly elastic, cut-resistant, extra-long 2:2 knitted trim

StretchFlex® HPT® Cut D, the glove for when things get tough: cut protection and grip strength for cutters, wire rope, glass and sheet metal work. Contact heat test class 1 (100 degrees, 15 seconds). The lightweight glove for extreme situations. Touch-screen compatible and washable at 40 °C.

**Material:**

Knitted fabric: PES steel polyamide  
Coating: non-slip HPT®

**Sizes:**

M/8–XXL/11



55



Item 100154



These items may also interest you:



P. 193



P. 81



P. 155



P. 98



P. 50



**NEW FEATURES**

 EN 388  
 ANSI A1 Cut  
 ANSI 4 Abrasion  
 STRETCHFLEX  
 TOUCHSCREEN CAPABILITY  

## StretchFlex® Fine Grip

- StretchFlex® technology
- Oil-resistant nitrile palms
- Breathable and antibacterial Sanitized
- Excellent tactile sensitivity and grip
- Slip-free handling
- High washing resistance at 40°C
- The top-selling glove
- Touchscreen compatible

The StretchFlex® Fine Grip features an oil-resistant nitrile coating and palm nubs for non-slip handling. Contact heat test class 1 (100 degrees, 15 seconds). Thanks to the StretchFlex® technology, the material at the back of the hand is very flexible and very breathable. A comfortable fine knit cuff prevents foreign objects from entering. Touchscreen compatible.

**Material:**  
Upper: nylon/nitrile foam

**Sizes:**  
XXS/5–3XL/12



16 

Item 100050

→  
These items may also interest you:





WORK PROTECTION



FORESTRY



TREE CARE



EN 388



STRETCHFLEX

## StretchFlex® Kepro

- StretchFlex® technology
- Kepro reinforcement
- Durable inseam on Velcro band
- Elastic band with Velcro
- For oily and greasy work
- Elastic knitted fabric at the back of the hand

StretchFlex® Kepro, the very robust goatskin glove for optimal grip and durability. The StretchFlex® technology allows almost unlimited freedom of movement.

**Material:**

Goatskin, PES, Armortex® PU

**Sizes:**

XS/6–XXL/11



19

Item 101915



These items may also interest you:



P. 191



P. 75



P. 81



P. 55



P. 127



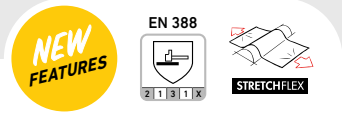

## StretchFlex® KeproTechnic

- StretchFlex® technology
- Ideal for technical work
- Non-slip fingertips
- Elastic neoprene waistband with Velcro
- Ergonomic Kepro palm reinforcement
- Moisture- and oil-resistant Alcantara fabric
- Elastic knitted fabric at the back of the hand

StretchFlex® KeproTechnic – the robust, ergonomically shaped glove, made of high-quality Alcantara fabric, with Kepro reinforcement for optimum grip even in wet conditions. Ideal for technical work thanks to the non-slip fingertips and the extra soft, elastic backing. StretchFlex® KeproTechnic – easy-care and washable at 30 °C – without any reduction in wearing comfort, even after repeated wearing and washing.

**Material:**  
Alcantara material  
Genuine leather thumb-index finger reinforcement

**Sizes:**  
M/8 – 3XL/12



19

Item 101917

→  
These items may also interest you:





WORK PROTECTION



FORESTRY



OUTDOOR



EN 388



STRETCHFLEX

## StretchFlex® Allround

- StretchFlex® technology
- Elastic knitted hand back
- Elastic band at the wrist
- Quick to put on and take off
- Integrated, full-leather ergonomic thumb

The Allround is a lightweight glove made of soft goatskin. Robust knitted fabric at the back of the hand with an internal elastic makes it easy to put on and take off quickly.

**Material:**

Goatskin, PES

**Sizes:**

XS/6–XXL/11



19

Item 100006



These items  
may also  
interest you:



P. 104



P. 116



P. 141



P. 62



P. 26



WORK PROTECTION



FORESTRY



TREE CARE



OUTDOOR



EN 388



STRETCHFLEX



THERMO

## StretchFlex® Thermo

- StretchFlex® technology
- For assembly in dry cold conditions
- Supple goatskin
- Elastic band with Velcro and elastic knitted hand back
- Roughened inner lining
- Integrated, full-leather ergonomic thumb

The StretchFlex® Thermo is a winter glove that adapts perfectly to the hand shape thanks to the proven StretchFlex® technology and the elastic knitted backing. This thermal glove stands out with its very good grip thanks to the seamless palm and the very soft goatskin. The StretchFlex® Thermo is ideal for cold and dry work.

**Material:**  
Goatskin, nylon

**Sizes:**  
M/8–XXL/11



19



Item 100003



These items may also interest you:



P. 191



P. 95



P. 69



P. 111



P. 140





WORK PROTECTION



FORESTRY



TREE CARE



OUTDOOR



4 | 3 | 2 | 1 | B



X | 2 | X



Cut



Abrasion



THERMO

## StretchFlex® Winter Grip

- StretchFlex® technology
- Extra warm thanks to a double insulation and a supple acrylic lining
- Oil- and abrasion-resistant nitrile palm areas with nubs
- Breathable and antibacterial Sanitized
- Slip-free handling
- High washing resistance at 40 °C
- Touchscreen compatible

The StretchFlex® Winter Grip is especially suitable for frosty, cold days due to the warm, double lining. Oil-resistant nitrile coating and nubs on the palm areas for a non-slip handling. Thanks to the StretchFlex® technology, the material at the back of the hand is very flexible and breathable. A comfortable fine knit cuff prevents foreign objects from entering. Touchscreen compatible.

### Material:

Upper: nylon/nitrile foam  
Lining: acrylic

### Sizes:

M/8–XXL/11



12

Item 100094



These items  
may also  
interest you:



P. 193



P. 61



P. 81



P. 98



P. 129

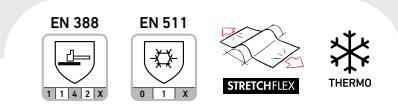

## StretchFlex® Ice Grip

- StretchFlex® technology
- Best grip for ice and wetness
- High breathability
- Particularly suitable for ski touring
- Washable
- Elastic Velcro band

StretchFlex® Ice Grip – the grippy thermal knitted glove for cold days. The fingertips and palm are reinforced with an acrylic coating. Due to the roughened coating, this reinforcement is extremely water-repellent, slip-resistant and particularly suitable for wet and cold, frosty days. The comfortable elastic wristband with Velcro prevents foreign objects from entering.

**Material:**  
Acrylic, latex

**Sizes:**  
M/8–XXL/11



16 

Item 102241

→  
These items may also interest you:



P. 191



P. 95



P. 79



P. 111



P. 141





RENNER







PrimaLoft® Gold Insulation



## Wool Felt Gloves

- Extra thick felt-knitted glove
- Can be worn with free fingers or as a mitten
- Especially for extreme cold weather
- Reinforced and slip-free palm
- PrimaLoft® Gold insulating lining

The Wool Felt Gloves are perfect for those very cold days when you need your fingers free quickly. The mittens can also be worn as finger-free gloves. A press-stud allows the attachment of the finger covers to the back of the hand. Additionally, the knitted gloves have a comfortable fit and a reinforced non-slip palm. PrimaLoft® Gold insulating lining against cold and moisture.

### Material:

58 % acrylic, 24 % nylon, 15 % wool, 3 % spandex  
Lining: 100 % PrimaLoft® Gold

### Sizes:

7/8 (S-M), 9/10 (L-XL)



38

Item 102414



These items may also interest you:



P. 163



P. 107



P. 74



P. 159



P. 141

# CE STANDARDS

## EN 388

### Mechanical hazards

The higher the number, the better the test result.

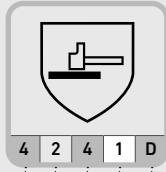

Test criteria	Review options	
Scrub-resistance	0-4	0-6
Cut-resistance (Blade Cut Test)	0-5	A1-A9
(Continuous) Tear-resistance	0-4	
Puncture-resistance	0-4	
Cut-resistance (ISO 13997)	A-F	

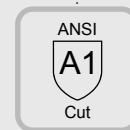

## EN 511

### Protection against the cold

The higher the number, the better the test result.

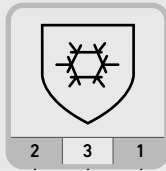

Test criteria	Review options
Convective coldness	0-4
Contact coldness	0-4
Waterproofness	0-1

# SIZE CHART

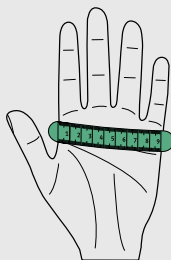

cm	Size
5	XXS
6	XS
7	S
8	M
9	L
10	XL
11	XXL
12	3XL

#### Determining the glove size

Measure your inner palm with a ruler or tape measure as shown in the illustration. In the example on the left, the inner palm measures 9 cm wide. This gives you a glove size 9 or size L.



WORK PROTECTION



FORESTRY



TREE CARE

Flexprotect Arm and Back  
of the Hand ProtectionFlexprotect Allround  
Chainsaw Protection

class 1 20m/s

## Flexprotect Arm and Back of the Hand Protection

- Dyneema chainsaw protection class 1
- Knitted cuff prevents the intrusion of sawdust
- A loop for the thumb and little finger prevents twisting of the arm chainsaw protection
- Additional 8 cm over the back of the hand

**Material:**

Upper: 83 % EME lycra, 17 % PES T-400  
Lining: 100 % PES

**Sizes:**

M+L

Item 804177 (right)

Item 804178 (left)



40



class 1 20m/s

## Flexprotect Allround Chainsaw Protection

- Dyneema chainsaw protection class 1
- Knitted cuffs prevent the intrusion of sawdust at both ends
- Allround chainsaw protection
- Prevents injuries with the hand saw

**Material:**

Upper: 83 % EME lycra, 17 % PES T-400  
Lining: 100 % PES

**Sizes:**

One size

Item 804161



40



These items  
may also  
interest you:



P. 193



P. 50



P. 146



P. 85



P. 123





FROM CLEVER  
TO COOL.

# OUR ACCESSORIES.

Whether it is a cleverly designed Zipp2Zipp® Backpack, perfectly fitting Nexus Safety Glasses or elastic Gladiator® Suspenders. Whether it is an elegant leather Belt or traditional organic Leather Balm.

**Our versatile range of accessories stands out with its quality and functionality.**

For all PFANNER® and PROTOS® fans, there are cool accessories, such as fashionable Caps or a practical Pocket Knife.



## Charlotte

Merino Thermolite Slouchy Beanie .....	161
Polar Jacket .....	35
StretchFlex® Fine Grip .....	145
Globe Outdoor Pants .....	71
AIRstream Zipp2Zipp® Backpack .....	174





WORK PROTECTION



FORESTRY



TREE CARE



HUNTING



OUTDOOR



100% MEMBRAN FREE



HUMIDITY MANAGEMENT



MERINO



100% MEMBRAN FREE



HUMIDITY MANAGEMENT



MERINO

## Merino AirSoft Cap

- Natural moisture management
- Soft merino wool for scratch-free wear
- Anti-odour
- Perforation for increased ventilation
- Pressure-free flatlock seams
- Recommended under the PROTOS®

**Material:**

99 % merino wool, 1 % spandex

**Sizes:**

One size



36 90

Item 107023

## Merino Knitted Cap Lana

- Right-left full knitted hat
- Soft merino wool for scratch-free wear
- Natural moisture management
- Recommended under the PROTOS®

**Material:**

100 % merino wool

**Sizes:**

One size



36 90

Item 100186



These items may also interest you:



P. 187



P. 191



P. 193



P. 162



P. 140





## Merino Knitted Cap Falcon

- Windproof microfleece inner headband
- Merino wool for natural moisture management
- Right-left knit with a 2/2 ribbing

**Material:**  
50 % merino wool, 50 % acrylic  
Headband: 100 % PES

**Sizes:**  
One size

## PrimaLoft® Gold Knitted Beanie

- Three-layer, PrimaLoft® Gold lining for insulation, 100% water-repellent
- Extremely breathable and stretchy
- Windstopper in forehead and ear area
- Lightweight

**Material:**  
Upper material: 100 % acrylic  
Lining: 100 % PrimaLoft® Gold

**Sizes:**  
One size



36 

Item 100189



90  36  65 

Item 101320

→  
These items may also interest you:



P. 111



P. 95



P. 33



P. 153



P. 141







## Merino Thermolite Slouchy Beanie

- Two-layer knitted cap
- Thermolite interior lining
- High-tech moisture management
- Does not scratch
- Water-repellent
- Highly elastic
- 1/1 rib stitch

Classic Slouchy knit cap with merino outer and Thermolite inner lining. The fine merino wool does not itch even during extended wear. The Thermolite inner cap ensures 100 % moisture management. The merino wool outer cap provides the best insulation and odourless characteristics. Highly elastic 1/1 adjustable turnover cuff. Popular for years with a unique high-tech moisture management.

**Material:**  
 Outside: 100 % merino wool  
 Inside: 100 % Thermolite

**Sizes:**  
 One size



Item 100187

→  
 These items may also interest you:



P. 111 P. 42 P. 35 P. 153 P. 68





WORK PROTECTION



FORESTRY



TREE CARE



HUNTING



OUTDOOR



sympatex®



## Nanoshield® MaClip Rain Hat

- 100 % waterproof thanks to Sympatex
- Magnetic side fastening of the brim
- Stepless adjustment for head size and chinstrap

The brim of the hat can be fixed up on both sides, thanks to the magnetic fastener. No getting stuck and functional up to wind force 10. The rain hat is 100 % waterproof.

Available in two colour versions: black and neon yellow-neon red for optimum visibility.

**Material:**  
100 % PES Sympatex

**Sizes:**  
One size



Item 106689



These items may also interest you:



P. 73



P. 107



P. 81



P. 147



P. 45



## Wool Felt Knit Cap

Extra thick double felt knit cap. Perfect for the outdoors, with felted outside right knit and inside ribbing 1/1. The design offers a tight grip on the head. The seamless processing prevents an unpleasant sensation of pressure.

- Extra thick double hat in felted knit.
- For windy, cold days
- Right-right knit
- 100 % shape-retaining
- Seamless processing

**Material:**  
61 % acrylic, 26 % nylon, 10 % wool, 3 % elastane

**Sizes:**  
One size



38

Item 102415

## Reflective Beanie / Reflective Headband

In warning colour with reflective strip for increased visibility. Micro-fleece with windstopper keeps you warm even on cold and windy days.

- High visibility
- 3M Scotchlite reflective strips
- Microfleece with continuous windstopper
- Extension at the ears

**Material:**  
100 % PES

**Sizes:**  
One size



Item 104270 Headband  
Item 104271 Beanie

27

27



These items may also interest you:



P. 93



P. 25



P. 61



P. 153



P. 29



Hockey Cap



Meta Cap



Baseball Cap



Alcantara Cap

## Baseball Cap

The long proven and functional cap with exclusive logo and PFANNER® embroidery, terry cloth sweatband and ventilation slots. A must-have.

**Material:**  
100 % PES micro

**Sizes:**  
Velcro size adjustment  
from 50–62 cm

Item 100021

## Hockey Cap

The stylish cap with exclusive PFANNER® and Holzer embroidery is an optical eye-catcher. Smooth and pressure-free thanks to the sweatband. The six air holes ensure good air exchange.

**Material:**  
100 % PES

**Sizes:**  
Metal slide size adjustment  
from 50–62 cm

Item 104382

## Alcantara Cap

PFANNER® Alcantara Cap in vintage leather look. Best fit due to the stepless size adjustment. Alcantara material is extremely robust, hard-wearing and easy-care at the same time.

**Material:**  
100 % PES

**Sizes:**  
Metal slide size adjustment  
from 50–62 cm

Item 104384

## Meta Cap

Brimless cotton cap for a maximum field of vision and perfect fit thanks to the opening of the folded edge.

**Material:**  
100 % cotton

**Sizes:**  
Velcro size adjustment  
from 47–66 cm

Item 100020



These items  
may also  
interest you:



P. 165



P. 104



P. 138



P. 75



P. 34





Spirit Warn-Air Cap



Spirit Flex-Air Cap



Day Bag

## Spirit Flex-Air Cap

The Spirit Flex-Air Cap stands out with its refreshing mesh fabric on hot days. One-size, wide, pressure-free highly elastic rubber band with integrated sweatband for maximum support and comfort.

**Material:**  
100 % PES

**Sizes:**  
One-size rubber band



36

Item 104385

## Spirit Warn-Air Cap

Striking neon colours for best visibility. Hygienic microfibre sweatband and integrated mesh for maximum air exchange on hot days. The microfibre upper provides ideal wearing comfort.

**Material:**  
100 % PES

**Sizes:**  
Metal slide size adjustment from 50–62 cm

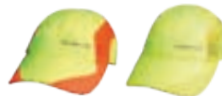

17

15

Item 104383

## Day Bag

Robust and extra large day bags with reflective stripes for high visibility. Printed on both sides.

**Material:**  
100 % PES

**Sizes:**  
42 × 50 cm



15 25 47

84 85 86

36

Item 107175



These items may also interest you:



P. 194



P. 146



P. 158



P. 191



P. 116



## Suspenders Classic

Robust, elastic and yet soft suspenders for buttons.  
Adjustable in the front and back.

**Material:**

Elastic strap: 53 % PES, 36 % polyamide, 11 % elastane

**Sizes:**

Adjustment to all sizes in front and back  
by means of metal clip.

Item 100016

36 ● 40 ●



## Gladiator® Suspenders

Elastic yet soft suspenders. Adjustable length by means of Velcro.  
Fits all PFANNER® pants and safety pants with suspender loops.

**Material:**

Elastic strap: 53 % PES, 36 % polyamide, 11 % elastane

**Sizes:**

Size 1: up to 180 cm height,  
adjustment with Velcro in front and back  
Size 2: over 180 cm height,  
adjustment with Velcro in front and back

Item 100240

36 ●



These items  
may also  
interest you:



P. 75



P. 83



P. 81



P. 79



P. 64



100% MEMBRAN FREE

## Zipp-off Suspenders

Zip-able back protection with pressure-free suspenders. Adjustable length by means of Velcro. Fits all outdoor pants and safety pants with back zipper and front loops.

### Material:

Kidney-bib suspender: 92 % polyamide, 8 % elastane  
Elastic strap: 53 % PES, 36 % polyamide, 11 % elastane

### Sizes:

Size 1: up to 180 cm height,  
adjustable with Velcro in front  
Size 2: over 180 cm height,  
adjustable with Velcro in front

Item 100043

25 36 40   
51 38 90



100% MEMBRAN FREE



## Loden Suspenders

For the PFANNER® Loden Pants we offer this Zip-off Back Part. Length adjustable by means of Velcro.

### Material:

Kidney-bib suspender: 67 % merino wool, 25 % polyamide,  
5 % alpaca wool, 3 % elastane  
Elastic strap: 53 % PES, 36 % polyamide, 11 % elastane

### Sizes:

Size 1: up to 180 cm height,  
adjustable with Velcro in front  
Size 2: over 180 cm height,  
adjustable with Velcro in front

Item 101772

38



These items  
may also  
interest you:



P. 85



P. 74



P. 71



P. 104



P. 187





Tool Pouch  
Model A

Tool Pouch  
Model B



Knee Pads



Vario Knee Protector



## Tool Pouch (A/B)

**Model A:** Two compartments and tool holder  
**Model B:** Two compartments for screws, nails etc.

**Material:**  
Gladiator® fabric 100 % polyamide

**Sizes:**  
20×24 cm  
For belts up to max. 6 cm wide

36 ● 38 ● 90 ●

Item 100058 Model A  
Item 100059 Model B

## Knee Pads

Well-mouldable insert pads with high damping characteristics. The pad can remain in the pants during washing.

**Material:**  
Cellular rubber

**Sizes:**  
225×165×12 mm

Item 100009 (1 pair)

## Vario Knee Protector

Shapable knee protector with high cushioning properties. The protector can remain in your pants during washing. Climatized knee protection and shock protection. Large air holes provide maximum ventilation.

**Material:**  
Cellular rubber, polyurethane

**Sizes:**  
220×160×15 mm

Item 100262 (1 pair)



These items  
may also  
interest you:



P. 65



P. 61



P. 65



P. 61



P. 62

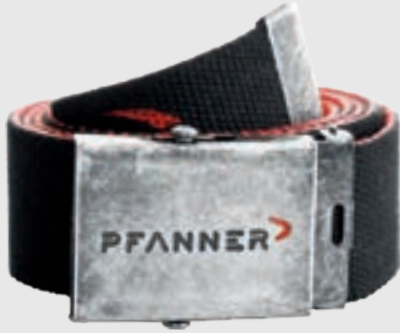

Belt 4 cm width



Stretch Belt Forest Green



Juchten Leather Belt



Belt 3 cm width



Stretch Belt Black



## Belt

The belt from PFANNER® with elegant embossing at the closure. Available in two different versions, each in two sizes.

### Material:

Width 3 cm: 100 % polypropylene, flip-top style buckle  
Width 4 cm: 100 % acrylic, slider pin-style buckle

**Sizes: (Easy to shorten belt)**  
Different sizes



Item 100018	3 cm × 120 cm
Item 101181	3 cm × 140 cm
Item 101906	4 cm × 120 cm
Item 101914	4 cm × 140 cm

## Juchten Leather Belt

Elegant belt made of 3 mm thick brown Juchten leather. The screw on the buckle allows easy shortening of the belt length without damaging the embossing on the belt tip.

### Material:

100 % Juchten leather,  
3 mm thick, 4 cm wide

**Sizes: (Easy to shorten belt)**  
4 cm × 100–160 cm



Item 104268

## Stretch Belt

- Robust material
- Fits the waistband on any pants perfectly
- Convenient quick-release buckle
- Length can be shortened as necessary
- No retightening required
- Stepless adjustable buckle

### Material:

65 % PES, 35 % elastane  
100 % nickel-free metal buckle

**Sizes: (Easy to shorten belt)**  
120 cm long, 4 cm wide



Item 101912

36 ● 38 ●



These items may also interest you:



P. 64



P. 73



P. 137



P. 139



P. 187







 EN 166 | EN 170



 EN 166 | EN 172



 EN 166 | EN 172



## Nexus Vario 3 Safety Glasses

Nexus Vario 3, maximum protection in every situation. Vertical Vario three-step adjustment, horizontal Vario extension, flexible and soft Vario nose pad for pressure-free wear comfort and non-slip hold. Antifog, scratch- and chemical-resistant. Very light, only 29 g.

**Sizes:**  
One size adult

- Item 101903-87 Clear
- Item 101903-90 Grey
- Item 101903-50 Yellow



**3-stage inclination**  
to easily adapt to every face shape



**x-twist technology**  
for a flexible and comfortable fit to any head shape



**Soft, flexible nose bridge pads**  
for pressure-free wearing comfort and anti-slip grip



Nexus Bag  
Item 101904



These items may also interest you:



P. 165



P. 93



P. 29



P. 165



P. 61



**NEW**

## Gladiator® Gaiters

Newly developed, versatile Gaiters made of robust Cordura upper material for extreme conditions. Ergonomically divided, highly flexible elastic bands for an optimal fit. Suitable for all leg sizes. The full-length covered zip, with Velcro and snap fastener, allows for an easy put on and take off. Includes 1 pair of spare wires for self-assembly.

**Material:**

Cordura 100 % polyamide; heavy-duty wires to go underneath the shoe

**Sizes:**

One size, 40 cm long

Item 102321

38 ● 40 ●

## Functional Shoelaces

The special round wavy shape of the laces prevents the lacing from opening unintentionally.

**Material:**

100 % polyamide

**Sizes:**

85, 100, 110, 120, 140, 150 cm

Item 100044

36 ●

## Trax-Shoelaces

Extremely durable laces – braided polyamide for durability under harsh conditions. The patented melting procedure ensures the durability for a long time even at the ends.

**Material:**

100 % polyamide

**Sizes:**

110, 170, 190, 210, 220 cm

Item 106707

11 ●●



These items may also interest you:



P. 132



P. 127



P. 121



P. 133



P. 177



## ChainsenPro Shoe Snow Chains

- 11 Stainless steel claws
- Up to 14 mm spike's length
- Sturdy heel plate
- All eyelets reinforced – prevents tearing out
- Particularly robust during intensive use
- Flexible elastomeric rubber
- Can be put on and taken off in seconds
- Without additional straps and buckles
- Light and compact – 320 g (M)

### Material:

Chain: 100 % hardened stainless steel  
Strap: Elastomeric rubber with POM eyelet reinforcement

### Sizes:

M (36–40), L (40–44), XL (44–48)

ChainsenPro Snow Shoe Chains for a perfect shoe grip on ice, snow, slippery or steep terrain. This makes them the ideal companion for mountain and hiking tours as well as work and rescue missions. The shoe snow chains are suitable for a wide range of shoes, from lightweight hiking boots to insulated rubber boots. The POM eyelets prevent the chain from tearing out. The elastomeric rubber, which is flexible down to -20 °C, ensures that the chain can be put on and taken off easily and quickly. The total weight is only 320 g and fits into any backpack with the practical packsack – package 160×113×72 mm.

Item 107173 (without shoes)

25 (M) ● 36 (L) ● 90 (XL) ●

## Shoe Tree

Adjustable Shoe Tree made of 100 % beech wood for the natural removal of moisture and odours. Extremely important for soaked leather shoes. The correct tight fitting of the Shoe Tree prevents deformation of the shoe during drying or prolonged storage.

### Sizes:

39–48

Item 100064



These items may also interest you:



P. 129



P. 124



P. 177



P. 120



P. 123



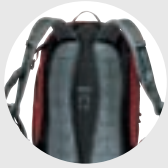

KlimaAIR® carrying system  
with AIRstream back padding

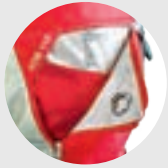

Zipp2Zipp®  
triple compartment

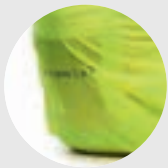

Integrated rain cover

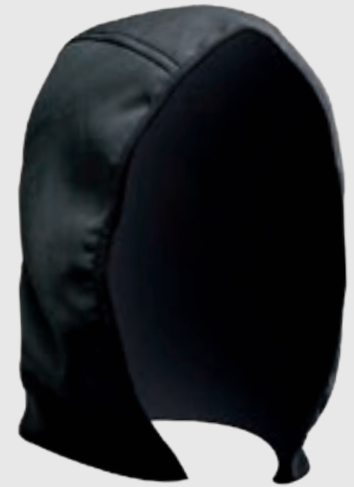

Softshell hood



3M ScotchLite



NEW

## AIRstream Zipp2Zipp® Backpack

- Patented Zipp2Zipp® triple compartment
- Extra large reflective stripes
- Waterproof cover for PROTOS®
- MaClip for the easiest opening and safest closing
- Holder for hiking poles
- Integrated, waterproof rain cover in neon yellow
- Colour-coordinated zip for the different compartments

Item 102007

Its maximum ventilation through the AIRstream system, cool design with the proven Zipp2Zipp® triple compartment, its body-hugging shape and practical zip volume expansion are all particularly eye-catching. Not forgetting the extra large cover with the MaClip closure for the PROTOS®. Extra wide, full-length reflective stripes for more safety in the dark and additional neon yellow rain cover.

### Material:

Backpack: 100 % polyamide  
Rain cover: 100 % PES

### Sizes:

22 litres (+8 litre volume expansion)

## Softshell Hood

Upgrade with the Hood. All items of the Inuit series may be ordered with hoods in the future. In addition, the practical Softshell Hood is available for the Zipp2Zipp® Colour Fleece Jacket, the Polar Jacket and Polar Jacket Women as well as for the Grizzly Jacket and Grizzly Sweater. The hood will be sewn on directly when ordering.

### Material:

100 % polyester

### Sizes:

One size adult  
One size child

Item 106998 Adult

Item 106999 Child



These items  
may also  
interest you:



P. 189



P. 27



P. 92



P. 171



P. 68

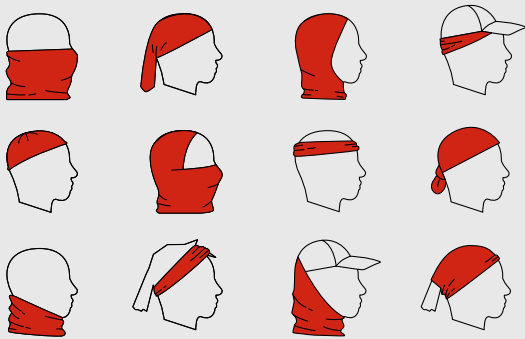

StretchAIR® Tubular wearing options



## StretchAIR® Tubular

Very supple, seamless and functional circular knitted tube made of highly flexible jersey. This head and neck scarf comes in a special design and offers the most diverse wearing options. So you are well prepared for every occasion.

**Material:**  
100 % PES

**Sizes:**  
50 cm long, 25 cm wide

Item 104349

## Gladiator® Wiff-Zack

Our sweet mascot – the "Wiff-Zack" in PFANNER®-PROTOS® design with the Holzer logo. The PFANNER® jacket is removable.

**Material:**  
Upper material: 100 % soft plush  
Filling: 100 % pure PES wadding

**Sizes:**  
approx. 20 cm high

Item 102331



These items  
may also  
interest you:



P. 18



P. 12



P. 13



P. 106



P. 115



PFANNER

LEDERBALSAM

Carnaubawachs  
Bienenwachs  
Ringelblumenöl

100% NATÜRLICH





## Detergency Booster

Liquid, highly concentrated Detergency Booster for cleaning of soiled protective clothing. Heavily soiled areas are pre-treated using the Detergency Booster and left to soak before washing with a normal colour detergent. The Detergency Booster makes sure the clothing is clean again, even washing at 30–40 °C. Only clean cut-protection layers guarantee the function of the chainsaw protection (no sticking).

**Contents:**  
1 l

Item 100770



## Leather Balm

The traditional organic Leather Balm is especially suitable for seam sealing and care. Makes leather supple, water-resistant and extends its longevity.

**Contents:**  
320 ml

Item 100025



## Waterproofer

Leather and fabrics become water- and dirt-repellent without altering the transpiration. Extends the longevity of shoes and textiles.

**Contents:**  
300 ml

Item 101911



These items may also interest you:



P. 129



P. 81

This will take you to the care instructions for your shoes.



Scan the QR code and find the best care tips for your PFANNER® products.





Stainless Steel Insulated Bottle



Reflective Wrist Band



Holzer Pin silver, silver/gold



Tick Card



## Stainless Steel Insulated Bottle

Our high-quality Stainless Steel Insulated Bottle is extremely robust and scratch-resistant. Thanks to the innovative VICC technology, with vacuum and a copper layer between the two stainless steel walls, it keeps heat for 18 hours and cold for 24 hours.

**Sizes:** 750 ml  
**Material:** Stainless Steel

## Reflective Wrist Band

Elastic, reflective tape for high visibility. Universally applicable, adjustable by means of Velcro. For children and adults. Can also be worn on the calf.

**Sizes:** One size

## Holzer Pin

The official Holzer logo as a high quality pin. Available in silver and silver/gold.

**Sizes:** 4x2.5 cm

## Tick Card

Remove ticks precisely and safely. The Tick Card from PFANNER® makes it easy. The tick is removed using the special card cut-out. In this way, the risk of transmission of dangerous bacteria can be reduced.

**Sizes:** 8.5x5.5 cm

Item 101966 Grey ●

Item 100080

Item 100045 Silver ●  
 Item 100046 Silver/Gold ●●

Item 100600



These items may also interest you:



P. 104



P. 159



P. 42



P. 30



P. 29



zippo



Lighter

VICTORINOX



Pocket Knife



Keyring PROTOS®



Keyring PFANNER®

## Zippo Lighter

Robust, durable and always ready to use, just like our clothing. It ignites even with wind, rain and snow and looks extremely classy. Can be filled with lighter fuel (supplied without fuel).

**Sizes:**  
5,5×3,5×1,3 cm

## Pocket Knife

You are always well equipped – even on the road – with the Victorinox Pocket Knife. The knife has 12 functions: tweezers, small blade, reamer-punch, ring, can opener, screwdriver 3 mm, Phillips screwdriver 1/2, large blade, toothpick, bottle opener, screwdriver 6 mm, wire stripper.

**Sizes:**  
9×2×1,5 cm

## Keyring

We enjoy working with systems, that's why we at PFANNER® offer a keyring with a system. Extremely practical because of the removable rings. This way you can get a grip of your large key-collection.

**Sizes:**  
7,5 cm

Item 106789

Silver ●

Item 102284

Item 101631 PFANNER®  
Item 102047 PROTOS®



These items may also interest you:



P. 174



P. 164



P. 35



P. 121



P. 103





**THE ORIGINAL.  
SINCE 2012.**



# PROTOS®

## PERFECTION IN EVERY DETAIL.

The safest head protection in the world. Since its market launch in 2012, PROTOS® has become the absolute benchmark. Created in Vorarlberg / Austria and traditionally manufactured in the region, PROTOS® incorporates the most innovative technologies in every detail to make everyday work in extreme hazardous areas significantly safer.

We are looking forward – based on a unique idea, we are constantly developing PROTOS® to meet tomorrow's challenges today.

**For maximum protection.**

<b>Safety and comfort</b>	<b>184</b>
<b>Industry</b>	<b>187</b>
<b>Climber</b>	<b>189</b>
<b>Forest</b>	<b>191</b>
<b>Arborist</b>	<b>193</b>
<b>BT-COM</b>	<b>194</b>
<b>Headset</b>	<b>196</b>
<b>Accessories</b>	<b>198</b>
<b>Colour system</b>	<b>203</b>
<b>Unique</b>	<b>204</b>



<b>Jonas</b>	
PROTOS® Forest .....	191
PROTOS® BT-COM .....	194
Forest Light Jacket .....	53
Gladiator® Keptec Chainsaw Protection Pants .....	78
StretchFlex® Fine Grip .....	145
Tyrol Juchten Class 1 Chainsaw Protection Boot .....	135





# PROTOS®

## DISCOVER THE DIVERSITY OF THE SYSTEM.

Get your PROTOS®  
on your smartphone.



1

Scan the QR code of the  
desired PROTOS® model  
(pages 186, 188, 190, 192).



2

Open the online app "zappar"  
and allow the use of the camera  
if requested.



3

Point the camera at the  
image next to the QR code  
and configure PROTOS®  
according to your wishes.

# SAFETY



All-round protection thanks to EN 397 and EN 12492 certifications



2-colour combination for increased visibility



Neck protector cradle, protects the back of the head in case of falls

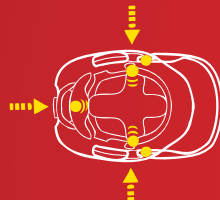

3-point suspension and shock absorber structure



Integrated face protection



PROTOS® safety glasses



Safety-ventilation slider



Integrated hearing protection



Hearing protection also serves as shock protection



5-times shock absorption with the PROTOS® CrashAbsorber



# COMFORT



Active  
ventilation

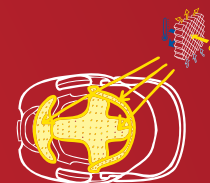

KlimaAIR®  
Technology



Replaceable  
and washable  
KlimaAIR® set

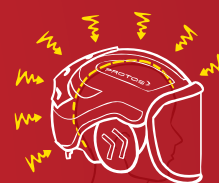

Precisely adjusted  
inner shell for the  
perfect fit



Handling with  
just two fingers



Profound,  
adjustable  
neck cradle



Wearing comfort  
due to specially  
guided chin straps



Patented size  
adjustment



PROTOS® BT-COM  
for a perfect  
communication

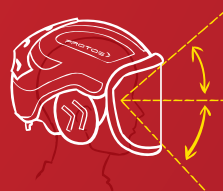

Largest field  
of vision



Scan the QR code  
for details.







EN 397



EN 1078\*



ANSI Z89.1

\* Certified according to EN 1078 bicycle helmets with PROTOS® MaClip chin strap (Item 204043)

## PROTOS® Industry

### Patents and design patents:

EP no. 2 498 636  
EU-Design no. 1731167  
Swiss Design no. 137 620  
US-Design Patent no. D677,006  
EP-Patent no. 2 498 635  
EU-Design no. 1 974 528  
DE-Design no. 20 2012 101 489

For building industry and civil engineering, assembly and maintenance or other varied activities. Outstanding safety paired with unparalleled wearing comfort provide all-round head protection.

PROTOS® has an unobstructed field of vision and absorbs optimally not only vertical, but also horizontal impacts. Thanks to its 20-step size adjustment on the patented quick-release neck cradle, it can adapt dynamically to any head shape. The adjustable ventilation slider and KlimaAIR® main pad ensure a dry and cool head.

**PROTOS® Industry – versatile,  
dynamic, colourful.**

### Sizes:

One size: 54–62 cm  
Large size: 56–64 cm

Item 202000

### ✓ Basic equipment



#### Neck cradle with clamping tab

Guarantees a perfect hold of the PROTOS® on the head.



Find our entire range of accessories starting on page 198.



Visors



MaClip Chin Strap



BT-COM System



Integral Hearing Protection (DB27)





360°







EN 397



EN 1078\*



EN 1077 B



EN 12492



ANSI Z89.1

\* Certified according to EN 1078 bicycle helmets and EN 1077 ski helmets class B with PROTOS® MaClip chin strap (Item 204043)

## PROTOS® Climber

### Patents and design patents:

EP no. 2 498 636  
EU-Design no. 1731167  
Swiss Design no. 137 620  
US-Design Patent no. D677,006  
EP-Patent no. 2 498 635  
DE-Patent no. 10 2011 054 945  
EU-Design no. 1 974 528  
DE-Design no. 20 2012 101 489

Item 203000

High altitude operations, technical accident, altitude or mountain rescue: PROTOS® is ideally suited for every mission.

PROTOS® is also equipped with the MaClip chin strap and a CrashAbsorber with a guaranteed 5-times higher shock absorption. The high-tech honeycomb structure, in combination with the ventilation slider, ensures optimal airflow directly around the head. More safety and unparalleled wearing comfort make PROTOS® perfect whether it's sunny or rainy.

**PROTOS® Climber – head protection for top performance.**

### Sizes:

One size: 54–62 cm  
Large size: 56–64 cm

### ✓ Basic equipment



#### CrashAbsorber

Super-light high-tech honeycomb structure for a 5 times higher shock absorption.



Find our entire range of accessories starting on page 198.



Safety Glasses



Actioncam-Bracket with Safety Loop



MaClip Light



KlimaAIR® Set









ANSI Z89.1



EN 352-3



EN 1731 S



EN 397

## PROTOS® Forest

### Patents and design patents:

EP no. 2 498 636  
EU-Design no. 1731167  
Swiss Design no. 137 620  
US-Design Patent no. D677,006  
EP-Patent no. 2 498 635  
EP-Patent no. 2 506 731  
US-Patent no. 8,806,667  
EU-Design no. 1 974 528  
DE-Design no. 20 2012 101 489

The forestry sector and its extreme requirements were and still are the starting point for the development of PROTOS®.

From the visor to the hearing protection, all components are integrally designed and prevent snagging on branches, bushes or thorns. Even when the visor or the hearing protection are in a park-position, PROTOS® stays perfectly on the head.

High-quality accessories make PROTOS® the first choice in forestry and tracking, regardless of whether it's cold and wet or hot and dry – with no ifs or buts.

**PROTOS® Forest – for unconditional use.**

### ✓ Basic equipment



#### KlimaAIR® Set

Main and neck pad, as well as headband, for an ideal airflow around the head. Washable up to 30 °C.

**Item 204000** with Metal Visor G16  
**Item 204002** with Metal Visor F39

#### Sizes:

One size: 54–62 cm  
Large size: 56–64 cm



Find our entire range of accessories starting on page 198.



CrashAbsorber



Clip-on Clear Visor



Neck Protector



Wall and Transport Mount





360°







EN 397



EN 1078\*



EN 1077 B



EN 1731 S



EN 12492



ANSI Z89.1

\* Certified according to EN 1078 bicycle helmets and EN 1077 ski helmets class B with PROTOS® MaClip chin strap (Item 204043)

## PROTOS® Arborist

### Patents and design patents:

EP no. 2 498 636  
EU-Design no. 1731167  
Swiss design no. 137 620  
US-Design Patent no. D677,006  
EP-Patent no. 2 498 635  
EP-Patent no. 2 506 731  
US-Patent no. 8,806,667  
DE-Patent no. 10 2011 054 945  
EU-Design no. 1 974 528  
DE-Design no. 20 2012 101 489

Item 205000 with Metal Visor G16  
Item 205002 with Metal Visor F39

The premium class of the system, designed for precise work at lofty heights or upside down, the PROTOS® Arborist combines the advantages of all models.

Always perfectly equipped, PROTOS® is up to any challenge and ready for use at any time. A complete integral equipment, as result of an innovative and proven development.

**PROTOS® Arborist – simply the best.**

### Sizes:

One size: 54–62 cm  
Large size: 56–64 cm

### + Optional accessories



### BT-COM System

Reliable communication within the team thanks to the Bluetooth® technology.



Find our entire range of accessories starting on page 198.



Safety Glasses



Actioncam-Bracket with Safety Loop



Clip-on Clear Visor



Wall and Transport Mount

# PROTOS® BT-COM

Safety means being able to communicate reliably with your team in any situation. PROTOS® BT-COM enables reliable communication for up to four users in the intercom network via Bluetooth® technology.

Thanks to two-way digital communication, radio interference is overcome. An additional advantage is the directional gooseneck microphone, which suppresses background noises by means of an additional integrated condenser and ensures clear communication.

A larger range can be achieved by combining the device with a mobile phone or handheld radio. The PROTOS® BT-COM is very easy to use with just three buttons.

Full-duplex communication ensures that the users can talk to each other at the same time and without delay, for at least 8 hours.

Of course, the BT-COM is fully integrated into the hearing protection capsule providing a dynamic park-position of the BT-COM capsule into the PROTOS®.

**PROTOS® BT-COM – communicate clearly from dawn to dusk.**

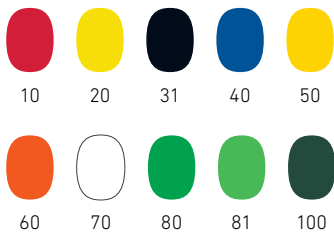

Item 205200



**PROTOS® colour system:**  
See at a glance the wide range of available PROTOS® colours on page 203.







✓ Basic equipment  
BT-COM Microphone Pad



⊕ Optional accessories  
BT-COM Absorption Insert  
(1 piece)



✓ Basic equipment  
BT-COM USB-Charging Bracket



⊕ Optional accessories  
BT-COM Shoulder-activated  
Talk Button

## What makes PROTOS® BT-COM stand out:

- Up to four users in the intercom network
- Range several hundred metres
- Uninterrupted and clear communication
- Possible use as Bluetooth-headset for Bluetooth-enabled devices such as mobile phones, audio devices, GPS navigation devices, handheld radios, Bluetooth intercoms
- No cables or connectors
- Extremely easy to operate even with gloves
- Free smartphone app „PROTOS® Control“ with useful additional functions (e.g. coupling with handheld radios / emergency number etc.)
- Only 42 g extra weight including battery
- Microphone with background noise suppression
- Possible unrestricted park-position of the BT-COM capsule into the PROTOS®
- Supplied USB-charging bracket
- Choice of 10 colours



### PROTOS® Video

Our film shows you an insight into the PROTOS® system.  
Just scan the QR code and watch the film.









## PROTOS® Headset

- Space-saving
- Foldable
- No protruding parts
- Replaceable PROTOS® hearing protection capsule
- Headband with pressure-free support pads
- Can be combined with the Headset Glasses Clips and the PROTOS® Safety Glasses without compromising the sound insulation of the hearing protector
- Compatible with PROTOS® BT-COM

Item 204068

With the unique PROTOS® Headset, you are equipped for every application. The headband can be configured individually by simply combining it with the BT-COM and/or the safety glasses. The extremely light construction and the special placement of the support pads prevent pressure points to arise.

Regardless of the position, the headband stays in place and does not slip. The safety glasses can be mounted directly without the 28 dB insulation value being reduced by the brackets. Tested and approved according to EN 352-1.

**Light, compact, practical.**

### ✓ Basic equipment



Space-saving and foldable

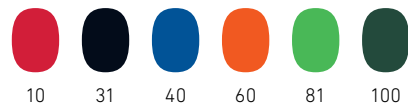

10 31 40 60 81 100



Find our entire range of accessories starting on page 198.



Combinable with Protective Glasses



Headset Bracket



Headset Glasses Clips



BT-COM System



# PROTOS® ACCESSORIES

## Face protection

---



### PROTOS® Etch Metal Visor

Face shield visor with 16 or 39 openings per cm<sup>2</sup>. The special coating reflects sunlight and prevents the visor from icing-up in sub-zero temperatures.

Item 204064 G16  
Item 204063 F39



### PROTOS® Clip-On Clear

PET-protective shield, in a set of 5 screens, incl. fixings. The etch metal visor can be converted into a closed visor in no time (e.g. for clearing saw activities). Provides also protection by the clear visor (e.g. against scratches) and can be easily replaced.

Item 204072



### PROTOS® Clear Visor

The polycarbonate visor is tested and approved according to EN 166, protection class 1 F (1 = maximum optical quality, F = increased strength and resistance to high-speed particles).

Item 204071



### PET Replacement Protective Shield in a set of 5

(excl. fixings), 0.4 mm

Item 204052



### PROTOS® Safety Glasses

100 % anti-fog (except by colour 30), tested and approved according to EN 166 / EN 172 (colours 30 and 60) according to EN 166 / EN 170 (colours 0 and 50). Advantages: no impairment of sound insulation, as glasses are attached to the head-band, adjustable in length and tilt, nose bridge adaptable to nose size, can be slid up with 2 fingers into the helmet. (Protects from dust and scratches).

Item 204090



### PROTOS® Optical Insert

For the installation of optical lenses at your optician's, correcting up to +/- 4 dioptries by means of a template.

Item 204094

## Lighting



**PROTOS® MaClip Light**  
LED safety lamp, certified by DEKRA (EN 60079), waterproof. 120 lumens.

**Item 204074** (left)  
**Item 204074** (right)



**PROTOS® MaClip Light Integral Holder**  
Magnetic clip system for the PROTOS®. Holder for mini and normal lamp. Installation only possible via PROTOS GmbH or authorised retailers.

**Item 204076**



**PROTOS® MaClip Light Lamp Holder**  
Magnetic clip system for the MaClip Light.

**Item 204075**



**PROTOS® MaClip Light mini**  
LED safety lamp, certified by DEKRA (EN 60079), waterproof. 30 lumens.

**Item 204044**



**PROTOS® MaClip Light Belt Holder**  
Magnetic clip system for fastening to a belt.

**Item 204077**



**PROTOS® MaClip Light mini Lamp Holder**  
Magnetic clip system for the MaClip Light mini.

**Item 204045**

## Basics



**PROTOS® Outer Shell**  
Available in 10 basic colours. Modification only by PROTOS GmbH or authorised retailers.

**Item 204030**



**PROTOS® MaClip Chin Strap**  
Certified according to EN 12492 – mountaineering helmet, EN 397 – industrial safety helmet, EN 1077 – ski helmet class B, EN 1078 – bicycle helmet.

**Item 204043**



**PROTOS® CrashAbsorber**  
Light honeycomb structure for a 5 times shock absorption. Certified according to EN 12492, EN 397, EN 1077 Class B and EN 1078. Assembly only by PROTOS GmbH or authorised retailers.

**Item 204080**



**PROTOS® KlimaAIR® Headband**  
Hygienic headband for great wearing comfort and quick drying. Includes guide rail to clip-on. Washable up to 30 °C.

**Item 204070**



**PROTOS® Neck Protector**  
Clipable, to protect against dirt and moisture.

**Item 204065**



**PROTOS® KlimaAIR® Set**  
Set to replace the absorption and hygiene pads. Washable up to 30 °C.

**Item 204060**

## Sizes



**PROTOS® Neck Pad Small Size**  
Extra thick padding (approx. 2 cm) for a small head circumference.

**Item 204051**



**PROTOS® Neck Closure Large Size (56–64 cm)**  
Enlargement of the head circumference. The closure is always supplied in the same colour as the shell, free of charge in case of direct mounting.

**Item 204050**

## Hearing Protection



**PROTOS® Hearing Protection (dB27)**  
To be clipped into the PROTOS®. Adjustable contact pressure and ear position. Available in 10 colours.

**Item 204067**



**PROTOS® Headset Bracket**  
Can be combined with hearing protection and/or BT-COM, as well as with safety glasses. Available in 6 colours.

**Item 204061**



**PROTOS® Hearing Protection Capsule without Bracket**  
Available in ten colours.

**Item 204058 (pair)**  
**Item 204058\_1 (1 piece)**



**PROTOS® Hearing Protection Pads**  
Replacement pads for the hearing protection. We recommend the replacement every 6–12 months, or, at the latest, when the outer material hardens (impairment of the sound insulation).

**Item 204062 (pair)**



**PROTOS® Hearing Protection Bracket**  
Replacement brackets suitable for hearing protection capsules and BT-COM.

**Item 204057**



**PROTOS® Hearing Protection Sound Insulation Insert**  
For hygiene reasons, replace the inserts regularly.

**Item 204059 (pair)**



**PROTOS® Hearing Protection Bracket for Large Sizes**  
Essential for oversized heads, when the standard hearing protectors do not fit properly.

**Item 204056**



**PROTOS® Coolmax® AIR Pads**  
Suitable for earmuffs and BT-COM. No sound insulation.

**Item 204069 (pair)**



**PROTOS® 3M™ Peltor™ Communication Attachment Bracket**  
Suitable for all 3M™ Peltor™ communication headsets where the microphone is attached to the radio capsule or to the hearing protection bracket (with fixings).

**Item 203019-10 (without fixings)**  
**Item 203019-20 (with fixings)**



**PROTOS® Headset Glasses Clips**  
Bracket for clipping the safety glasses onto the headset.

**Item 204096 (pair)**



# MORE POSSIBILITIES. MORE PROTECTION.

## BT-COM



**PROTOS® BT-COM Insulation Insert**  
Item 204211 (1 piece)



**PROTOS® BT-COM USB-Charging Bracket**  
Item 204201



**PROTOS® BT-COM Microphone Pads**  
Item 204212



**PROTOS® BT-COM Shoulder-activated Talk Button**  
To extend the multifunction button, adhesive included. Activated with the shoulder.  
Item 205202

## Miscellaneous



**Actioncam-Bracket with Safety Loop**  
To attach an Actioncam securely to the PROTOS® (visor can be opened normally).  
Item 204047



**PROTOS® Wall and Transport Mount**  
Simple attachment for space-saving storage, ventilation or quick drying of the PROTOS®.  
Item 205400

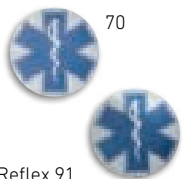

Reflex 91

**„Star of Life“ Sticker**  
International symbol for the institutions of the emergency service. Individual sticker, in the form of reflective or standard blue-white film, Ø 4 cm.  
Item 102084  
Item 102067 Reflex



**Holzer Logo Adhesive**  
Item 306003  
Size 1 (3.5 × 4.5 cm)  
Size 2 (6.5 × 8.5 cm)  
Size 3 (14.5 × 20 cm)

# Base colours and standard stickers

We present you our base colours and standard stickers for all the PROTOS® models. There are countless possibilities to customise the colour design – go to next page for more information.

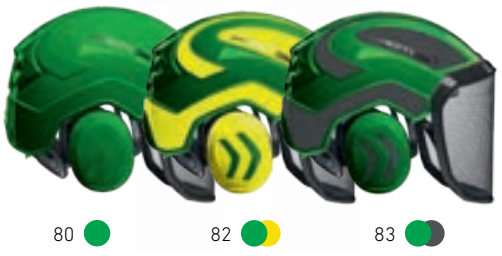

# PROTOS® COLOUR SYSTEM



## Outer shell

Choose the outer shell from 10 basic colours.



## Film colour

The outer shell can be covered with various films on the areas provided for this purpose.

In 28 colours, made of different materials and in neon, reflex, metallic, carbon, luminescent or matt.

**Surcharge for customised stickers orders.**

<b>10</b> RED	<b>11</b> CARBON	<b>110</b> PINK	<b>115</b> NEON PINK	<b>20</b> NEON YELLOW	<b>30</b> GREY
<b>31</b> BLACK	<b>40</b> BLUE	<b>45</b> BLUE METALLIC	<b>60</b> ORANGE	<b>66</b> NEON RED	<b>67</b> NEON ORANGE
<b>68</b> NEON RED-ORANGE	<b>70</b> WHITE	<b>77</b> LUMINESCENT	<b>80</b> GREEN	<b>85</b> NEON GREEN	<b>29</b> LEMON REFLEX
<b>49</b> BLUE REFLEX	<b>91</b> WHITE REFLEX	<b>92</b> BLACK REFLEX	<b>94</b> LIGHT BLUE REFLEX	<b>95</b> YELLOW REFLEX	<b>96</b> ORANGE REFLEX
<b>97</b> RUBY REFLEX	<b>98</b> GREEN REFLEX	<b>99</b> SILVER WHITE REFLEX	<b>34</b> BLACK MATT		



# PROTOS® UNIQUE HEAD SAFETY WITH YOUR PERSONAL DESIGN.

## Safety or styling – why not both?

Make your dream of a unique PROTOS® come true and design it according to your personal ideas. Choose the colour combination you like and customise the PROTOS® with your logo, name or pattern according to your wishes. Thus, the head protection becomes a unique personal PROTOS® not only thanks to the accessories, but also through your creativity.

All options for an easy design at [protos.at](https://www.protos.at) or at one of the over 500 authorised PROTOS® partners.

## Customisation

Whether in company colours, with a company logo or a picture – we design your PROTOS® individually. Either using adhesives on the shell or by visor and capsule printing.

- **Customised text and logo elements**
- **Free choice of base colour**
- **Customised adhesive on the outer shell**
- **4c UV printing on the hearing protection capsules**
- **4c UV printing on the etched metal visor**  
(does not alter the visibility)

## Printing on the capsules

To complete the unique piece is also possible a customised design of the hearing protection capsules.







WE ARE HERE  
FOR YOU.





# OUR SERVICE.

We own a dense network of distributors all over the world, which we are constantly expanding. We are also expanding our distribution channels constantly, to meet the rising demand.

If you want to **place an order** or have any questions about our products, please give us a call. Our service team is available by phone from Monday to Friday from 8 a.m. to 5 p.m. at **+43 59 50 50-200**.

You can also get advice from your specialist dealer.

You may **return or exchange\*** our products within 14 days of purchase. For this, please fill out our return form completely, so that we can process your return quickly.

If you need a **repair service**, just send a short description of the fault and if possible a photo to your dealer\* or directly to us:

**info@pfanner-austria.at**

PFANNER® customer support will find the ideal solution for you quickly and easily.

\* Please observe the applicable requirements of your dealer and the corresponding laws in the respective country.



## Anna

PROTOS® Inuit Jacket – Kids .....	10
Maximus Outdoor Pants .....	18

## Stephanie

Merino-Tencel™ Shirt .....	93
StretchFlex® Cancool Pants .....	64
Brixen Trekking Shoe .....	121

## Accessories

AIRstream Zipp2Zipp® Backpack .....	174
-------------------------------------	-----

Person description from left to right.

# FINISHING

Strong appearance with image clothing. It is like your own textile business card. With materials that are colour-matched to the corporate design and your logo or lettering you can set company-specific highlights and promote the recognition value. Positive side effect: Image clothing also enlivens the team spirit of your employees.



We support you in the colour design and the placement of your logo and advertisement by printing or embroidery at the appropriate location.

Consultation, design and final artwork of the garments are free of charge. We look forward to your inquiry.

Simply contact us at [info@pfanner-austria.at](mailto:info@pfanner-austria.at) or by phone: **+43 59 50 50-200**.

You can also get advice from your specialist dealer.

## Transfer Emblems

Transfer emblems are an excellent choice, especially if sharp contours and small subtleties must be implemented properly. T-shirts, sweatshirts and polo-shirts are ideal for the application of this technique. But your prints will also appear perfectly on stretch materials and functional clothing. If not all emblems are needed for an order, we will store them free of charge for you. This way we can quickly produce small quantities or single items in subsequent orders. Starting at 25 identical emblems, we will perform your printing request.

## Screen printing

The classic printing process is extremely durable, resistant to washing and ideal for larger quantities, starting at 50 items. T-shirts, sweatshirts, polo-shirts and bags can be finished with colour gradients or multi-coloured motifs. Even photorealistic prints are possible. Nearly all textiles can be printed with an almost unlimited choice of colours. The colour is completely water-based and safe for the environment.

## Stick

Your protective clothing will look particularly high-quality if your logo or lettering is embroidered into the fabric. An embroidery gives a nice appearance and stands out for its great durability. Our first-class machines, needles and yarns, as well as our experience over many years, are the basis for a high-quality result. A wide range of thread colours allows us to present your motif in HKS or Pantone shades. In addition, this method is also applicable for smaller quantities. We only charge a small surcharge for less than 12 items. We embroider almost all types of textiles directly on the fabric. Our embroidery options on interchangeable Velcro are also very practical.

## Plot

Printing your name, large lettering or less detailed logos can ideally be implemented with this method, even in small quantities. We produce plot prints in different colours or even with light-reflecting effects.

# JACKETS



- Transfer, for 25 or more items, 1 to 6 colours
- Plot, for 1 or more item(s), 1 colour
- Direct embroidery
- Sewn embroidered emblem
- Embroidered emblem with Velcro
- Sewn woven emblem
- Patched on woven emblem

- 1 – right sleeve, 9×4.5 cm
- 2 – left sleeve, 9×4.5 cm
- 3 – right chest, 9×4.5 cm
- 4 – left chest, 9×4.5 cm
- 5 – front side or rear right, 25×6 cm, patch only, no reflective stripes, no zipper on clothes
- 6 – front side or rear left, 25×6 cm, patch only, no reflective stripes, no zipper on clothes
- 7 – back centre, 25×30 cm, for two-colour back: Size in the upper area: 25×20 cm
- 8 – right collar, 6×2 cm
- 9 – left collar, 6×2 cm
- 10 – right sleeve, 5×20 cm, patch only, no reflective stripes on clothes
- 11 – left sleeve, 5×20 cm, patch only, no reflective stripes on clothes

# PANTS

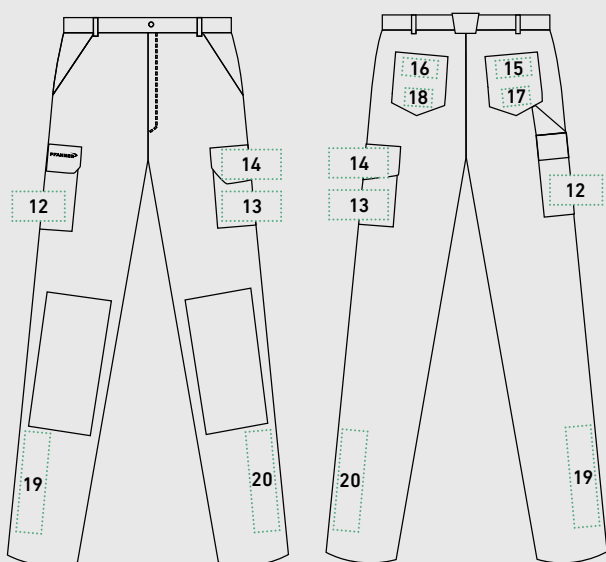

- Transfer, for 25 or more items, 1 to 6 colour
- Plot, for 1 or more item(s), 1 colour
- Direct embroidery
- Sewn embroidered emblem
- Sewn woven emblem
- Patched on woven emblem

- 12 – right side pocket, 8×4 cm
- 13 – left side pocket, 9×4 cm
- 14 – left side pocket flap, 9×4 cm
- 15 – right back pocket top, 9×4 cm
- 16 – left back pocket top, 9×4 cm
- 17 – right back pocket below, 7×4 cm
- 18 – left back pocket below, 7×4 cm
- 19 – right calf and shin side, 5×20 cm, patch only, no reflective stripes on clothes
- 20 – left calf and shin side, 5×20 cm, patch only, no reflective stripes on clothes

The finishing options in positions 9–15 have a delivery time of approx. 10–12 weeks.

You can request more design options, also for shirts and shorts, via e-mail to [info@pfanter-austria.at](mailto:info@pfanter-austria.at) or phone +43 59 50 50-200.



# SIZE CHARTS

## Women

Size	A Chest width in cm	B Waist pants in cm	C Inseam in cm
XXS	88	74	78
XS	92	80	78
S	98	86	78
M	104	92	78
L	110	98	78
XL	116	104	78

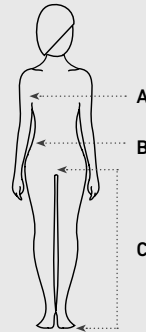

## Shoes

EU	UK Unisex
36	3.5
37	4
38	4.5
39	5
40	5.5
41	6
42	6.5
43	7
44	7.5
45	8
46	8.5
47	9
48	9.5
49	10
50	10.5
	11
	11.5
	12
	12.5
	13
	13.5
	14

## Men

Size	A Chest width in cm	B Waist pants in cm	C Inseam in cm		
			short	regular	long
XXS	78	74	75	80	87
XS	84	80	75	80	87
S	96	86	75	80	87
M	102	92	75	80	87
L	108	98	75	80	87
XL	116	104	75	80	87
XXL	124	110	75	80	87
3XL	132	116	75	80	87
4XL	138	122	75	80	87

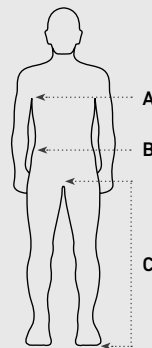

## StretchZone®

**STRETCHZONE**

Size	B Waist pants in cm	C Inseam in cm	
		regular	long
42	74	80	88
44	78	80	88
46	82	82	90
48	86	82	90
50	90	82	90
52	94	82	90
54	98	83	90
56	102	83	90
58	108	83	90
60	114	83	90
62	120	83	90

## Gloves

cm	Size
5	XXS
6	XS
7	S
8	M
9	L
10	XL
11	XXL
12	3XL

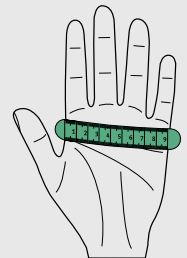

### Determining the glove size

Measure your inner palm with a ruler or tape measure as shown in the illustration. In the example, the inner palm measures 9 cm wide. This gives you a glove size 9 or size L.

# 500 PARTNER: OTHER COUNTRIES, SAME SAFETY.



## Europe:

Austria, Germany, Switzerland, Liechtenstein, Belgium, Netherlands, Luxembourg, UK, Ireland, France, Spain, Portugal, Italy, Denmark, Norway, Sweden, Finland, Slovenia, Czech Republic, Poland, Hungary, Estonia, Latvia and Lithuania.

## Other:

USA, Canada, Mexico, Peru, Chile, Australia, New Zealand, Japan, China, South Korea, Taiwan, Thailand, Russia and Israel.

More info at [pfanner-austria.at](http://pfanner-austria.at)

- **PFANNER Schutzbekleidung GmbH**



# IMPRINT

Price changes, misprints, technical changes and product developments reserved. The colours shown may differ from the original colours due to technical printing reasons. All personal terms used in this catalogue refer equally to all genders.



You can find the updated version of the catalogue via the QR code.

In this catalogue, only trademarks registered for the company PFANNER Schutzbekleidung GmbH are marked with the symbol "®". If the symbol "®" is missing, it does not mean that a trademark is unclaimed.

**Content:**

PFANNER Schutzbekleidung GmbH

**Realisation:**

Design Brunold, [www.debr.at](http://www.debr.at)

**Photography and 3D renderings:**

Lukas Hämmerle, [www.lukashaemmerle.com](http://www.lukashaemmerle.com)

Marcel Mayer, [www.marcelmayer.com](http://www.marcelmayer.com)

Brad Foster, [www.fostermedia.de](http://www.fostermedia.de)

Darko Todorovic, [www.darkotodorovic.com](http://www.darkotodorovic.com)

visionworks, [www.visionworks.eu](http://www.visionworks.eu)

**Image processing:**

Armin Kofler, [www.profiler.cc](http://www.profiler.cc)

**Print:**

Walstead Leykam Druck GmbH & Co KG,

[www.walstead-npdruck.com](http://www.walstead-npdruck.com)

**Contact:**

[info@pfanner-austria.at](mailto:info@pfanner-austria.at)







PFANNER

PFANNER

# PROTOS® UNIQUE HEAD SAFETY WITH YOUR PERSONAL DESIGN.



## Safety or styling – why not both?

Make your dream of a unique PROTOS® come true and design it according to your personal ideas. Further information can be found on page 204.

### PFANNER Schutzbekleidung GmbH

Herrschaftswiesen 11 | 6842 Koblach - Austria  
+43 59 50 50-200  
info@pfanner-austria.at | www.pfanner-austria.at

Specialist dealer:

**PFANNER**®